

Differential pressure gauge with output signal

For the process industry, high overload safety up to 400 bar

Models DPGT43HP.100 and DPGT43HP.160

WIKA data sheet PV 17.13



for further approvals see page 4

intelliGAUGE®

Applications

- Acquisition and display of process values
- Output signals 4 ... 20 mA, 0 ... 20 mA, 0 ... 10 V for the transmission of process values to the control room
- For measuring locations with a high differential pressure overload and/or high working pressures (static pressures), also in aggressive environments
- Easy-to-read, analogue on-site display needing no external power

Special features

- High working pressure (static pressure) and high overload safety, selectable up to 40, 100, 250 or 400 bar
- Hydraulic cushioning protection against rapid pressure changes
- No configuration necessary due to "plug-and-play"
- Differential pressure measuring ranges from 0 ... 60 mbar
- Individual, non-linear characteristic curves (e. g. x^2 or \sqrt{x} for flow measurement)

Description

Wherever the differential pressure must be indicated locally and, at the same time, a signal transmission to the central control or remote centre is desired, the model DPGT43 intelliGAUGE® (US patent: 8,030,990) can be used. The electronic WIKA sensor, integrated into the model 732.14 high-quality, mechanical differential pressure gauge, combines the advantages of electrical signal transmission with the advantages of a local mechanical display.

Even if the voltage supply is completely lost, the differential pressure can be read securely. The robust diaphragm measuring system produces a pointer rotation proportional to the pressure.

An electronic angle encoder, proven in safety-critical automotive applications, determines the position of the pointer shaft – it is a non-contact sensor and therefore completely free



Differential pressure gauge, model DPGT43HP.100

from wear and friction. From this, the electrical output signal, proportional to the pressure, of 4 ... 20 mA, is produced. In addition, the electrical zero point can be set manually.

These differential pressure measuring instruments are made of highly corrosion-resistant stainless steel. A high overload safety is achieved by the all-metal construction and the close-fitting design of the diaphragm pressure element.

The use of high-quality stainless steel materials and the robust design are geared to applications in the chemical and process engineering industries. Thus the instrument is suitable for liquid and gaseous media, also in aggressive environments.

Specifications

Mechanical data	
Mechanical version	Highest overload safety either side, pressure ratings PN 40, 100, 250 or 400, system fill fluid of the measuring cell acts as the damping for the display
Nominal size in mm	100, 160
Accuracy (mechanical display)	≤ 1.6 % of measuring span (class 1.6 per EN 837-3)
Scale ranges	0 ... 60 mbar to 0 ... 250 mbar (measuring cell DN 140, for dimensions see page 5) 0 ... 400 mbar to 0 ... 40 bar (measuring cell DN 80) or all other equivalent vacuum or combined pressure and vacuum ranges
Operating limits	Overload resistance per EN 837-3
Pressure limitation	
Steady	Full scale value
Fluctuating	0.9 x full scale value Observe the recommendations for the use of mechanical pressure measuring systems in accordance with EN 837-2
Overpressure safety / max. working pressure (static pressure)	Overload safety either side for the following pressure ratings: <ul style="list-style-type: none"> ■ PN 40: 40 bar ■ PN 100: 100 bar ■ PN 250: 250 bar ■ PN 400: 400 bar (only for scale ranges ≥ 0 ... 400 mbar)
Media chamber with process connection (wetted)	Stainless steel 316Ti (1.4571) Lower mount, 2 x G ½ female
System fill fluid for the measuring cell	Silicone oil
Pressure elements (wetted)	Scale ranges ≤ 0 ... 250 mbar: 316L stainless steel Scale ranges > 250 mbar: 316L stainless steel/Inconel
Venting of the media chambers (wetted)	PN 40/100: Standard for scale ranges ≤ 0 ... 160 mbar PN 250/400: Standard for scale ranges ≤ 0 ... 250 mbar Other scale ranges on request Material: 316Ti stainless steel (1.4571)
Movement	Stainless steel
Dial	Aluminium, white, black lettering
Pointer	Adjustable pointer, aluminium, black
Case	Stainless steel
Window	Laminated safety glass
Ring	Bayonet ring, stainless steel
Damping options	
For dynam. pressure load	Restrictor in the pressure port
For vibration	Liquid filling of the case
Permissible temperature range	
Medium	-20... +100 °C
Ambient	-20 ... +60 °C (with window from polycarbonate max. 80 °C)
Temperature effect	max. ±0.5 %/10 K of full scale value (when the temperature deviates from 20 °C reference temperature)
Ingress protection per IEC/EN 60529	IP54 (with liquid filling IP65)
Installation	according to affixed symbols: ⊕ high pressure, ⊖ low pressure
Mounting	<ul style="list-style-type: none"> ■ Rigid measuring lines ■ Mounting holes in measuring flange ■ Panel mounting flange (option) ■ Instrument mounting bracket for wall or pipe mounting (option)





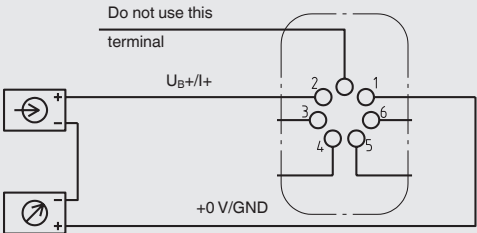

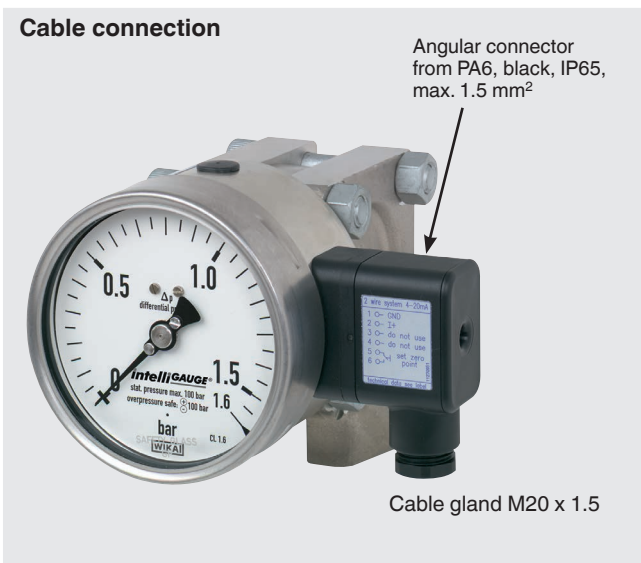

Options

- Sealings (model 910.17, see data sheet AC 09.08)
- Other process connections via female or male threads
- Other system fill fluids in the measuring cell, e.g. for use in oxygen environments
- Higher max. working pressure (static pressure) and higher overload safety (see table page 5)
- Output signal 0 ... 20 mA, 0 ... 10 V
- Customer-specific characteristic curve (also non-linear)
- Venting of the media chamber for scale ranges ≥ 0.4 bar
- Lateral connection location (right, left)
- Panel mounting flange
- Instrument mounting bracket for wall or pipe mounting
- Valve manifolds (models IV3x and IV5x, see data sheet AC 09.23)
- With switch contacts (data sheet PV 27.13)

Electrical data	
Power supply U_B	DC 12 V < U_B ≤ 30 V (variant 1) DC 14 V < U_B ≤ 30 V (variant 2)
Influence of power supply	≤ 0.1 % of full scale/10 V
Permissible residual ripple of U_B	≤ 10 % ss
Output signal	Variant 1: 4 ... 20 mA, 2-wire, passive, per NAMUR NE 43 Variant 2: 4 ... 20 mA, per ATEX
Permissible max. load R_A	$R_A \leq (U_B - 12 \text{ V})/0.02 \text{ A}$ with R_A in Ω and U_B in V, however max. 600 Ω
Effect of load	≤ 0.1 % of full scale
Impedance at voltage output	0.5 Ω
Electrical zero point	Through a jumper across terminals 5 and 6 (see operating instructions)
Long-term stability of electronics	< 0.3 % of full scale per year
Electr. output signal	≤ 1 % of measuring span
Linear error	≤ 1 % of measuring span (terminal method)
Resolution	0.13 % of full scale (10 bit resolution at 360°)
Refresh rate (measuring rate)	600 ms
Maximum values for the power supply circuit (only for Ex version)	
Power supply U_i	DC 30 V
Short-circuit current I_i	100 mA
Power P_i	1 W
Internal capacitance C_i	12 nF
Internal inductance L_i	Negligible
Electrical connection	Via angular connector, 180° rotatable, wire protection, cable gland M20 x 1.5, incl. strain relief, connection cable: Outer diameter 7 ... 13 mm, conductor cross-section 0.14 ... 1.5 mm ² , temperature resistance up to 60 °C
Designation of connection terminals, 2-wire	 <p>Do not use this terminal</p> <p>$U_B+/+$</p> <p>+0 V/GND</p> <p>Terminals 3 and 4: For internal use only Terminals 5 and 6: Reset zero point</p>



Approvals

Logo	Description	Country
	EU declaration of conformity <ul style="list-style-type: none"> ■ EMC directive ■ Pressure equipment directive ■ ATEX directive (option) 	European Union
	EAC (option) <ul style="list-style-type: none"> ■ EMC directive ■ Pressure equipment directive ■ Low voltage directive ■ Hazardous areas 	Eurasian Economic Community
	GOST (option) Metrology, measurement technology	Russia
	KazInMetr (option) Metrology, measurement technology	Kazakhstan
-	MTSCHS (option) Permission for commissioning	Kazakhstan
	BelGIM (option) Metrology, measurement technology	Belarus
	UkrSEPRO (option) Metrology, measurement technology	Ukraine
	DNOP (MakNII) (option) <ul style="list-style-type: none"> ■ Hazardous areas 	Ukraine
	Uzstandard (option) Metrology, measurement technology	Uzbekistan
-	CRN Safety (e.g. electr. safety, overpressure, ...)	Canada

Certificates (option)

- 2.2 test report per EN 10204 (e.g. state-of-the-art manufacturing, indication accuracy)
- 3.1 inspection certificate per EN 10204 (e.g. indication accuracy)

Patents, property rights

- Current output (2-wire) for pointer measuring instruments (US 8,030,990, CN101438333)

Approvals and certificates, see website

Dimensions in mm

Standard version

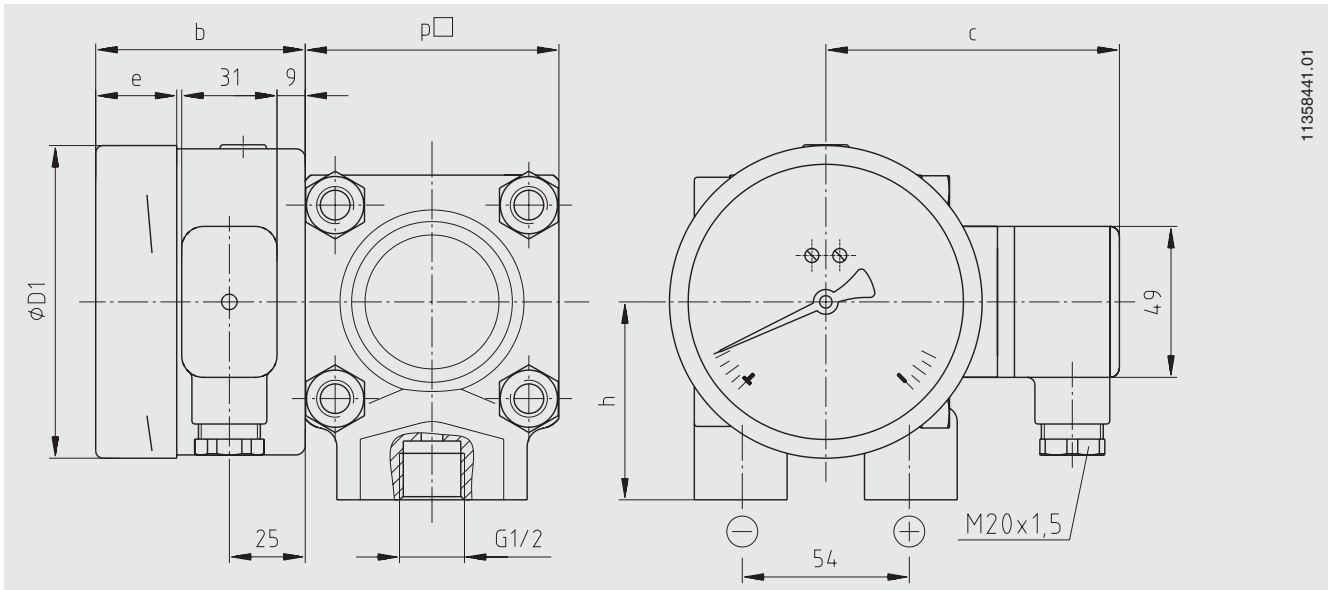

11358441.01

NS	Scale range	Dimensions in mm					Weight in kg		
		b	D1	h ±1	p□ (PN 40/100/250)	p□ (PN 400)	PN 40/100	PN 250	PN 400
100	≤ 0 ... 250 mbar	58.5	101	86	140	-	12.1	13.1	-
100	> 0 ... 250 mbar	58.5	101	64	82	86	3.6	3.9	4.5
160	≤ 0 ... 250 mbar	65.5	161	86	140	-	12.5	13.5	-
160	> 0 ... 250 mbar	65.5	161	64	82	86	4.0	4.3	4.9

Ordering information

Model / Nominal size / Scale range / Process connection / Connection location / Output signal / Scale layout (linear pressure or square root incrementation) / Max. working pressure (static pressure) / Options

© 05/2008 WIKA Alexander Wiegand SE & Co. KG, all rights reserved.
The specifications given in this document represent the state of engineering at the time of publishing.
We reserve the right to make modifications to the specifications and materials.

