

Miniature resistance thermometer

For sanitary applications, for orbital welding

Model TR21-B

WIKA data sheet TE 60.27



further approvals
see page 12

Applications

- Sanitary applications
- Food and beverage industry
- Bio and pharmaceutical industry, production of active ingredients

Special features

- Sensor can be calibrated without having to open the process
- Simple and fast electrical connection via M12 x 1 plug connector
- With direct sensor output (Pt100/Pt1000 in 3 or 4-wire version) or integrated transmitter with 4 ... 20 mA output signal, individually parameterisable with free-of-charge WIKAsoft-TT PC configuration software
- Wetted parts from stainless steel 1.4435
- Self-draining and dead-space minimised, materials and surface finish qualities in accordance with standards of hygienic design



Model TR21-B with flow-through housing

Description

The model TR21-B resistance thermometer provides temperature measurement in sanitary applications and can be used for the measurement of liquid and gaseous media in the range of -30 ... +150 °C (-22 ... +302 °F). For application in hazardous areas, intrinsically safe versions are available.

The connection ends are straight and prepared for orbital welding. The process connections meet the stringent requirements, in terms of materials and design, of hygienic measuring points. All electrical components are protected against moisture (IP67 or IP69K).

The resistance thermometer is available with direct sensor output or integrated transmitter, which can be configured individually via the PC configuration software WIKAsoft-TT. Measuring range, damping, error signalling per NAMUR NE43 and TAG no. can be adjusted.

For easy calibration or maintenance, the sensor is removable without having to break into the process or disconnect the electrical connection. Thus hygiene risks can be minimised and downtimes can be reduced.

The spring loading, integrated into the union nut, guarantees the contact between the sensor tip and the bottom of the thermowell and thus ensures a short response time and lasting high accuracy. Insertion length, process connection, sensor and connection method can each be selected for the respective application within the order information. The electrical connection is made via an M12 x 1 circular connector.

For applications requiring the sterilisation of the instrument in autoclaves, an especially temperature-resistant instrument version is available.

Specifications

Thermometer with transmitter and output signal 4 ... 20 mA (models TR21-B-xTT, TR21-B-xTB)	
Temperature range	-30 ... +150 °C (-22 ... +302 °F) ¹⁾
Measuring element	<ul style="list-style-type: none"> ■ Pt1000 ■ Face-sensitive Pt1000 ²⁾
Connection method	2-wire The lead resistance is recorded as an error in the measurement.
Tolerance value of the measuring element ³⁾ per IEC 60751	Class A
Measuring span	Minimum 20 K, maximum 300 K
Measuring deviation of the transmitter per IEC 60770	±0.25 K
Total measuring deviation in accordance with IEC 60770	Measuring deviation of the measuring element + the transmitter
Basic configuration	Measuring range 0 ... 150 °C (32 ... 302 °F), other measuring ranges are adjustable
Analogue output	4 ... 20 mA, 2-wire
Linearisation	Linear to temperature per IEC 60751
Linearisation error	±0.1 % ⁴⁾
Switch-on delay, electrical	Max. 4 s (time before the first measured value)
Warming-up period	After approx. 4 minutes, the instrument will function to the specifications (accuracy) given in the data sheet.
Current signals for error signalling	Configurable in accordance with NAMUR NE43 downscale ≤ 3.6 mA upscale ≥ 21.0 mA
Sensor short-circuit	Not configurable, in accordance with NAMUR NE43 downscale ≤ 3.6 mA
Sensor current	< 0.3 mA (self-heating can be ignored)
Load R _A	$R_A \leq (U_B - 10 \text{ V}) / 23 \text{ mA}$ with R _A in Ω and U _B in V
Effect of load	±0.05 % / 100 Ω
Power supply U _B	DC 10 ... 30 V
Max. permissible residual ripple	10 % generated by U _B < 3 % ripple of the output current
Power supply input	Protected against reverse polarity
Power supply effect	±0.025 % / V (depending on the power supply U _B)
Influence of the ambient temperature	0.1 % of span / 10 K T _a
Electromagnetic compatibility (EMC) ⁶⁾	EN 61326 emission (group 1, class B) and interference immunity (industrial application) ⁵⁾ , configuration at 20 % of the full measuring range
Temperature units	Configurable °C, °F, K
Info data	TAG no., description and user message can be stored in transmitter
Configuration and calibration data	Permanently stored
Response time (per IEC 60751)	t ₅₀ < 3.2 s t ₉₀ < 7.3 s
Electrical connection	M12 x 1 circular connector (4-pin)
Autoclavability (option)	Autoclavable with mounted protection cap at connecting plug (for further information see "Ambient conditions")
Explosion protection (option)	Intrinsically safe to Ex i (ATEX) gas/dust (for further information see "Further specifications for explosion-protected version")

Readings in % refer to the measuring span

- 1) The temperature transmitter should therefore be protected from temperatures over 85 °C (185 °F).
- 2) Through their small design, face-sensitive measuring resistors serve to reduce the heat dissipation with short insertion lengths. Available for the temperature range up to 150 °C (302 °F). For thermowell insertion lengths of less than 50 mm, face-sensitive measuring resistors are recommended. For thermowell insertion lengths of less than 11 mm, face-sensitive measuring resistors are generally used.
- 3) Specification is only valid for the measuring element. Depending on the process connection, the deviation can be greater.
- 4) ±0.2 % for measuring ranges with a lower limit less than 0 °C (32 °F)
- 5) Use resistance thermometers with shielded cable, and ground the shield on at least one end of the lead, if the lines are longer than 30 m or leave the building. The instrument must be operated grounded.
- 6) During transient interferences (e.g. burst, surge, ESD) take into account an increased measuring deviation of up to 2 %.

Thermometer with direct sensor output with Pt100 (model TR21-B-xPx) or Pt1000 (model TR21-B-xRx)	
Temperature range	-30 ... +150 °C (-22 ... +302 °F)
Measuring element	<ul style="list-style-type: none"> ■ Pt100 (measuring current 0.1 ... 1.0 mA) ■ Face-sensitive Pt100 (measuring current 0.1 ... 1.0 mA) ⁷⁾ ■ Pt1000 (measuring current 0.1 ... 0.3 mA) ■ Face-sensitive Pt1000 (measuring current 0.1 ... 0.3 mA) ⁷⁾
Temperature at the connector	Max. 85 °C (185 °F)
Connection method	<ul style="list-style-type: none"> ■ 3-wire With a cable length of 30 m or longer, measuring deviations can occur ■ 4-wire The lead resistance can be ignored
Tolerance value of the measuring element ⁸⁾ per IEC 60751	<ul style="list-style-type: none"> ■ Class AA ⁹⁾ ■ Class A
Response time (per IEC 60751)	t ₅₀ < 3.2 s t ₉₀ < 7.3 s
Electrical connection	M12 x 1 circular connector (4-pin)
Autoclavability (option)	Autoclavable with mounted protection cap at connecting plug (for further information see "Ambient conditions")
Explosion protection (option)	Intrinsically safe to Ex i (ATEX) gas/dust (for further information see "Further specifications for explosion-protected version")

For detailed specifications for Pt sensors, see Technical information IN 00.17 at www.wika.com.

Case	
Material	Stainless steel
Ingress protection	IP67 and IP69 per IEC/EN 60529, IP69K per ISO 20653 The stated ingress protection only applies when plugged in using mating connectors that have the appropriate ingress protection. IP67 per IEC/EN 60529
<ul style="list-style-type: none"> ■ Case with connected connector ¹⁰⁾ ■ Coupler connector, not connected 	
Weight in kg	Approx. 0.3 ... 2.5 (depending on version)

Ambient conditions	
Ambient temperature range	-40 ... +85 °C (-40 ... +185 °F) -50 ... +85 °C (-58 ... +185 °F)
<ul style="list-style-type: none"> ■ Models TR21-B-xTT, TR21-B-xTB ■ Models TR21-B-xPx, TR21-B-xRx 	
Storage temperature range	-40 ... +85 °C (-40 ... +185 °F)
Climate class per IEC 60654-1	Cx (-40 ... +85 °C or -40 ... +185 °F, 5 ... 95 % r. h.) Cx (-50 ... +85 °C or -58 ... +185 °F, 5 ... 95 % r. h.)
<ul style="list-style-type: none"> ■ Models TR21-B-xTT, TR21-B-xTB ■ Models TR21-B-xPx, TR21-B-xRx 	
Maximum permissible humidity per IEC 60068-2-30 var. 2	100 % r. h., condensation allowed
Maximum permissible autoclaving conditions	max. 134 °C, 3 bar abs., 100 % r. h., duration 20 min., max. 50 cycles
Shock resistance per IEC 60068-2-27	50 g, 6 ms, 3 axis, 3 faces, 3 times for each face
Salt fog	IEC 60068-2-11

Readings in % refer to the measuring span

- 7) Through their small design, face-sensitive measuring resistors serve to reduce the heat dissipation with short insertion lengths. Available for the temperature range up to 150 °C (302 °F). For thermowell insertion lengths of less than 50 mm, face-sensitive measuring resistors are recommended.
For thermowell insertion lengths of less than 11 mm, face-sensitive measuring resistors are generally used.
- 8) Specification is only valid for the measuring element. Depending on the process connection, the deviation can be greater.
- 9) Class accuracy AA only valid in the temperature range 0 ... 150 °C (32 ... 302 °F)
- 10) Not tested at UL

Thermowell model TW61	
Designs	<ul style="list-style-type: none"> ■ Flow-through housing ■ Angular housing
Nominal widths of pipe	cf. tables of dimensions
Surface roughness	Per DIN 11866 row A, B: Standard: $R_a < 0.8 \mu\text{m}$ Option: $R_a < 0.4 \mu\text{m}$ electropolished Per DIN 11866 row C, ASME-BPE: Standard: $R_a < 0.76 \mu\text{m}$ Option: $R_a < 0.38 \mu\text{m}$ electropolished others on request
Materials	Per DIN 11866 row A, B: stainless steel 1.4435 Per DIN 11866 row C, ASME-BPE: stainless steel 316L
Connection to thermometer	G 3/8"
Thermowell diameter	cf. tables of dimensions
Neck tube length M	The neck tube length M is adjusted to the length A of 60 mm. further lengths to customer specifications
Pressure ratings	cf. tables of dimensions
Pipe lengths TL and L ₁ , thermowell insertion length U ₁	cf. tables of dimensions

Conditions for outdoor use (for UL approval only)

- The instrument is suitable for applications with pollution degree 3.
- The power supply must be suitable for operation above 2,000 m should the temperature transmitter be used at this altitude.
- The instrument shall be installed in locations sheltered from the weather.
- The instrument shall be installed "sun/UV radiation protected".

Further specifications for explosion-protected version (optional)

- Thermometer with transmitter and output signal 4 ... 20 mA (models TR21-B-xTT, TR21-B-xTB)

Marking:

Hazardous gas atmosphere	Temperature class	Ambient temperature range (T _a)	Maximum surface temperature (T _{max}) at the sensor or thermowell tip
II 1G Ex ia IIC T1 - T6 Ga II 1/2G Ex ia IIC T1 - T6 Ga/Gb II 2G Ex ia IIC T1 - T6 Gb	T6	-40 ... +45 °C	T _M (medium temperature) + self-heating (15 K) Pay attention to the specific conditions for safe use.
	T5	-40 ... +60 °C	
	T4	-40 ... +85 °C	
	T3	-40 ... +85 °C	
	T2	-40 ... +85 °C	
	T1	-40 ... +85 °C	

Hazardous dust atmosphere	Power P _i	Ambient temperature range (T _a)	Maximum surface temperature (T _{max}) at the sensor or thermowell tip
II 1D Ex ia IIIC T135 °C Da II 1/2D Ex ia IIIC T135 °C Da/Db II 2D Ex ia IIIC T135 °C Db	750 mW	-40 ... +40 °C	T _M (medium temperature) + self-heating (15 K) Pay attention to the specific conditions for safe use.
	650 mW	-40 ... +70 °C	
	550 mW	-40 ... +85 °C	

Safety-related maximum values for the current loop circuit (+ and - connections):

Parameters	Hazardous gas atmosphere	Hazardous dust atmosphere
Terminals	+ / -	+ / -
Voltage U_i	DC 30 V	DC 30 V
Current I_i	120 mA	120 mA
Power P_i	800 mW	750/650/550 mW
Effective internal capacitance C_i	29.7 nF	29.7 nF
Effective internal inductance L_i	Negligible	Negligible
Maximum self-heating at the sensor or thermowell tip	15 K	15 K

■ **Thermometer with direct sensor output with Pt100 (model TR21-B-xPx) or Pt1000 (model TR21-B-xRx)**

Marking:

Marking	Temperature class	Ambient temperature range (T_a)	Maximum surface temperature (T_{max}) at the sensor or thermowell tip
II 1G Ex ia IIC T1 - T6 Ga II 1/2G Ex ia IIC T1 - T6 Ga/Gb II 2G Ex ia IIC T1 - T6 Gb	T6	-50 ... +80 °C	T_M (medium temperature) + self-heating Pay attention to the specific conditions for safe use.
	T5	-50 ... +85 °C	
	T4	-50 ... +85 °C	
	T3	-50 ... +85 °C	
	T2	-50 ... +85 °C	
	T1	-50 ... +85 °C	

Marking	Power P_i	Ambient temperature range (T_a)	Maximum surface temperature (T_{max}) at the sensor or thermowell tip
II 1D Ex ia IIIC T135 °C Da II 1/2D Ex ia IIIC T135 °C Da/Db II 2D Ex ia IIIC T135 °C Db	750 mW	-50 ... +40 °C	T_M (medium temperature) + self-heating Pay attention to the specific conditions for safe use.
	650 mW	-50 ... +70 °C	
	550 mW	-50 ... +85 °C	

Safety-related maximum values for the current loop circuit (connections in accordance with pin assignment 1 - 4):

Parameters	Gas applications	Dust applications
Terminals	1 - 4	1 - 4
Voltage U_i	DC 30 V	DC 30 V
Current I_i	550 mA	250 mA
Power P_i	1.500 mW	750/650/550 mW
Effective internal capacitance C_i	Negligible	Negligible
Effective internal inductance L_i	Negligible	Negligible
Maximum self-heating at the sensor or thermowell tip	(R_{th}) = 335 K/W	(R_{th}) = 335 K/W

Overview of the process connections

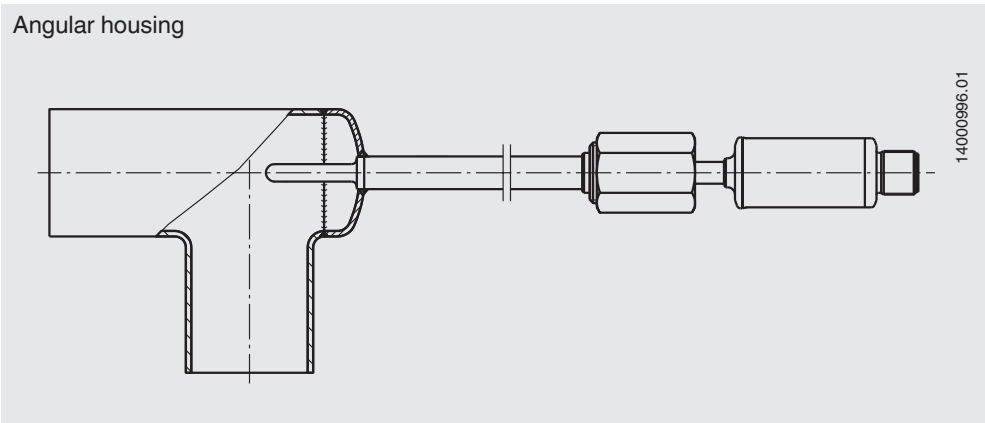
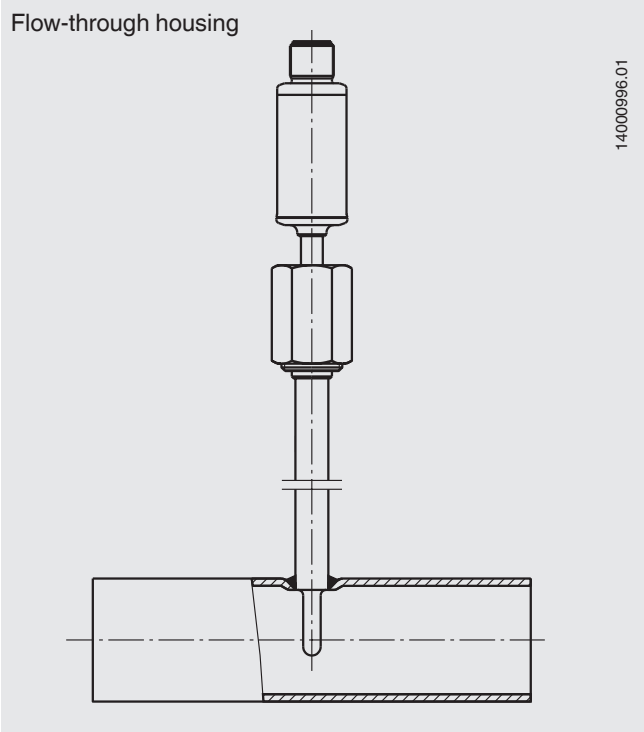

Dimensions of the process connections in mm (thermowells model TW61)

Flow-through housing

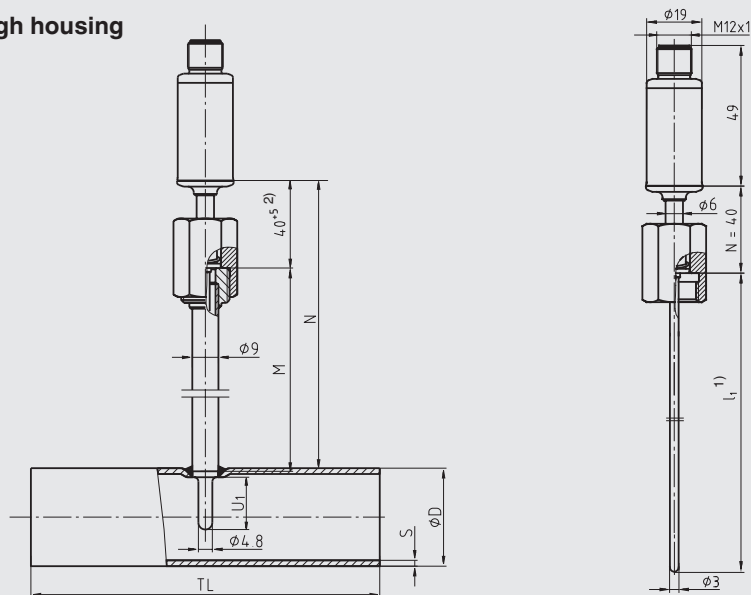

14000996.01

- 1) In the event of replacement, calculate the sensor insertion length, l_1 , as follows:
 $l_1 (TR21-B) = U_1 + M + 3 \text{ mm}$
- 2) The tolerance specification is dependent on the spring travel of the sensor/probe

Nominal width of pipe		Nominal pressure in bar	Outer diameter of pipe	Pipe schedule	Tube length	Thermowell insertion length	Neck tube length
DN / OD		PN ^{3) 4)}	Ø D	s	TL	U ₁	M
DIN 11866 row A or metric	10	25	13	1.5	70	6	51
	15	25	19	1.5	70	9	48
	20	25	23	1.5	80	11	46
	25	25	29	1.5	100	18	39
	32	25	35	1.5	110	18	39
	40	25	41	1.5	120	18	39
	50	25	53	1.5	160	30	27
	65	16	70	2.0	210	30	27
	80	16	85	2.0	260	45	32
	100	12.5	104	2.0	310	45	32
DIN 11866 row B or ISO	8 (13.5)	25	13.5	1.6	64	6	51
	10 (17.2)	25	17.2	1.6	68	9	48
	15 (21.3)	25	21.3	1.6	72	11	46
	20 (26.9)	25	26.9	1.6	110	11	46
	25 (33.7)	25	33.7	2.0	120	18	39
	32 (42.4)	25	42.4	2.0	130	18	39
	40 (48.3)	25	48.3	2.0	130	18	39
	50 (60.3)	25	60.3	2.0	180	30	27
	65 (76.1)	16	76.1	2.0	220	30	27
80 (88.9)	16	88.9	2.3	260	45	32	
DIN 11866 row C or ASME BPE	1/2"	13.8	12.7	1.65	95.2	6	51
	3/4"	13.8	19.05	1.65	101.6	9	48
	1"	13.8	25.4	1.65	108.0	11	46
	1 1/2"	13.8	38.1	1.65	120.6	18	39
	2"	13.8	50.8	1.65	146.0	18	39
	2 1/2"	13.8	63.5	1.65	158.8	30	27
	3"	13.8	76.2	1.65	171.4	30	27
	4"	13.8	101.6	2.11	209.6	45	32

3) Maximum operating temperature 150 °C

4) All thermowells of this series that are internally pressurised, with a nominal diameter (DN) > 25 mm, are manufactured and tested to module H of the Pressure Equipment Directive.

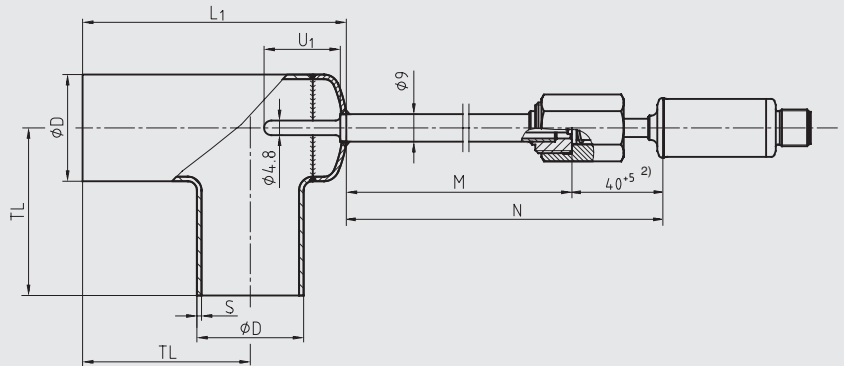

Angular housing

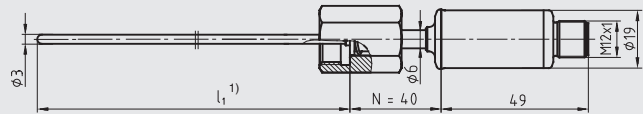

14000996.01

- 1) In the event of replacement, calculate the sensor insertion length, l_1 , as follows:
 $l_1 (TR21-B) = U_1 + M + 3 \text{ mm}$
 2) The tolerance specification is dependent on the spring travel of the sensor/probe





Nominal width of pipe		Nominal pressure in bar	Outer diameter of pipe	Pipe schedule	Tube length		Thermowell insertion length	Neck tube length
DN / OD		PN ^{3) 4)}	Ø D	s	TL	L ₁	U ₁	M
DIN 11866 row A or metric	10	25	13	1.5	35	55	14	43
	15	25	19	1.5	35	55	18	39
	20	25	23	1.5	40	63	18	39
	25	25	29	1.5	50	77	30	27
DIN 11866 row A or metric 	32	25	35	1.5	55	87	30	27
	40	25	41	1.5	60	97	30	27
	50	25	53	1.5	80	126	30	27
	65	16	70	2.0	105	165	45	32
	80	16	85	2.0	130	201	45	32
	100	12.5	104	2.0	155	241	45	32
DIN 11866 row B or ISO	8 (13.5)	25	13.5	1.6	32	55	14	43
	10 (17.2)	25	17.2	1.6	34	55	16	41
	15 (21.3)	25	21.3	1.6	36	58	18	39
	20 (26.9)	25	26.9	1.6	55	81	30	27
DIN 11866 row B or ISO 	25 (33.7)	25	33.7	2.0	60	91	30	27
	32 (42.4)	25	42.4	2.0	65	102	30	27
	40 (48.3)	25	48.3	2.0	65	108	30	27
	50 (60.3)	25	60.3	2.0	90	145	45	32
	65 (76.1)	16	76.1	2.0	110	173	45	32
	80 (88.9)	16	88.9	2.3	130	203	45	32
DIN 11866 row C bzw. ASME BPE	1/2"	13.8	12.7	1.65	47.6	71	14	43
	3/4"	13.8	19.05	1.65	50.8	71	18	39
	1"	13.8	25.4	1.65	54.0	79	18	39
DIN 11866 row C or ASME BPE 	1 1/2"	13.8	38.1	1.65	60.3	94	30	27
	2"	13.8	50.8	1.65	73.0	118	30	27
	2 1/2"	13.8	63.5	1.65	79.4	134	45	32
	3"	13.8	76.2	1.65	85.7	150	45	32
	4"	13.8	101.6	2.11	104.8	190	45	32

3) Maximum operating temperature 150 °C

4) All thermowells of this series that are internally pressurised, with a nominal diameter (DN) > 25 mm, are manufactured and tested to module H of the Pressure Equipment Directive.

Due to the variable neck tube length M, measuring inserts with standardised insertion lengths l_1 can be used. Thus, variance and stocking of spare parts are minimised. At the same time, the use of correct insertion lengths in the event of replacement is ensured.

Accessories

Model	Special features	Order no.	
Programming unit Model PU-548 	<ul style="list-style-type: none"> Easy to use LED status display Compact design No further voltage supply needed, neither for the programming unit nor for the transmitter <p>(replaces programming unit model PU-448)</p>	14231581	
Adapter cable M12 to PU-548 	Adapter cable for the connection of a model TR21-B resistance thermometer to the model PU-548 programming unit	14003193	
M12 sealing cap with mounted PTFE sealing	Sealing cap for protecting the resistance thermometer during sterilisation in autoclaves	14113588	
M12 connection cable	Cable socket straight, 4-pin, ingress protection IP67 <ul style="list-style-type: none"> Temperature range -20 ... +80 °C Suitable for hazardous areas 	Cable length 2 m	14086880
		Cable length 5 m	14086883
	Cable socket straight, 4-pin, ingress protection IP69K, Hygienic Design <ul style="list-style-type: none"> Temperature range -40 ... +80 °C Not for hazardous areas 	Cable length 3 m	14137167
		Cable length 5 m	14137168
	Angled socket, 4-pin, ingress protection IP67 <ul style="list-style-type: none"> Temperature range -20 ... +80 °C Suitable for hazardous areas 	Cable length 2 m	14086889
		Cable length 5 m	14086891
	Angled socket, 4-pin, ingress protection IP69K, Hygienic Design <ul style="list-style-type: none"> Temperature range -40 ... +80 °C Not for hazardous areas 	Cable length 3 m	14137169
		Cable length 5 m	14137170

Configuration software WIKAsoft-TT

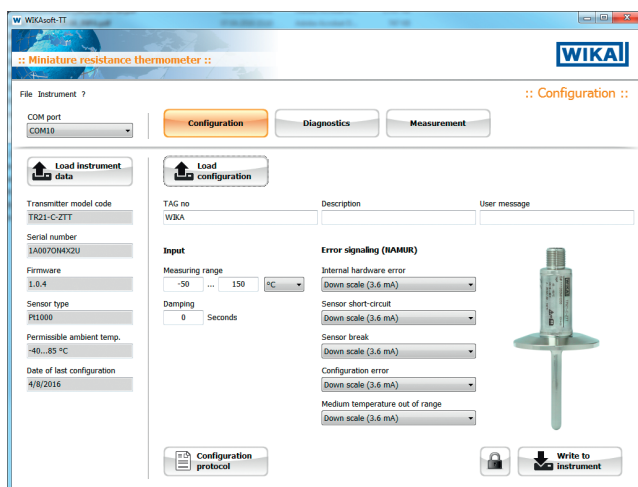

Configuration software (multilingual) as a download from www.wika.com

Connecting PU-548 programming unit

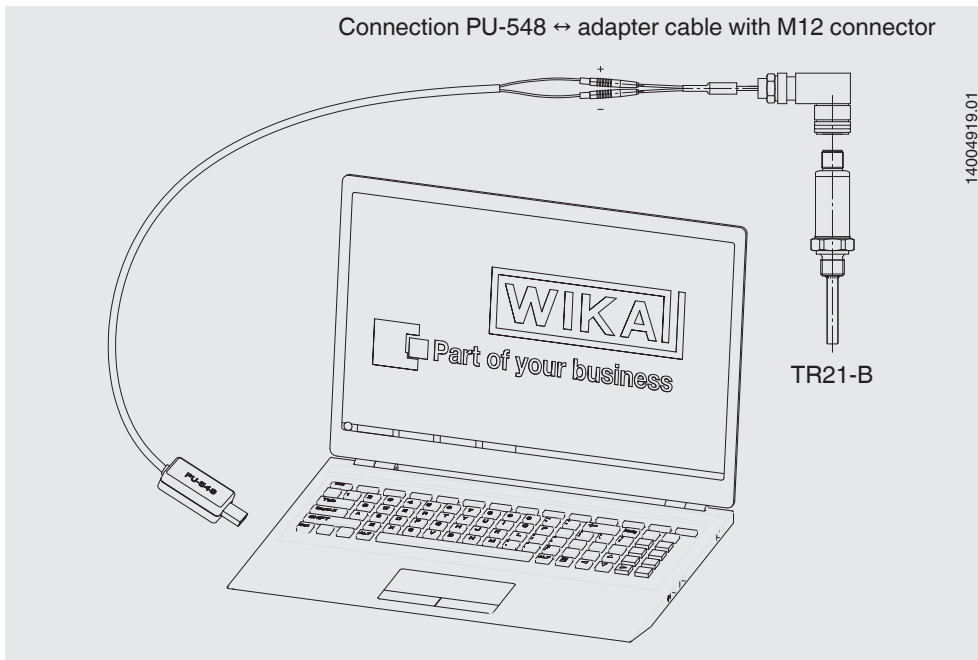

(predecessor, programming unit model PU-448, also compatible)

Electrical connection

Output signal 4 ... 20 mA
M12 x 1 circular connector (4-pin)

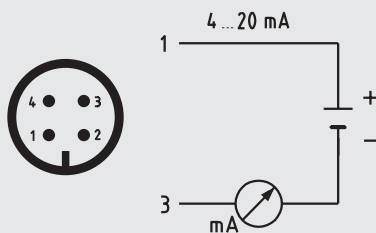

Pin	Signal	Description
1	L+	10 ... 30 V
2	VQ	not connected
3	L-	0 V
4	C	not connected

Output signal Pt100 sensor
M12 x 1 circular connector (4-pin)

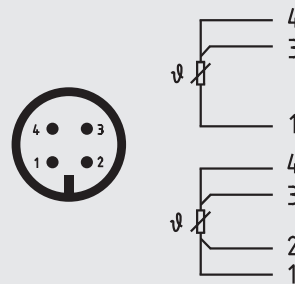

Load diagram

The permissible load depends on the loop supply voltage. For communication with the instrument with programming unit PU-548, a max. load of 350 Ω is admissible.

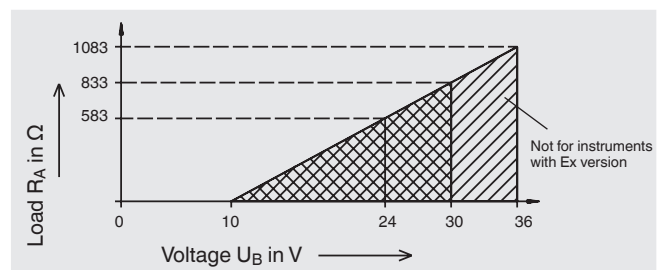

Application example

Temperature measurement for plant or measuring point validation

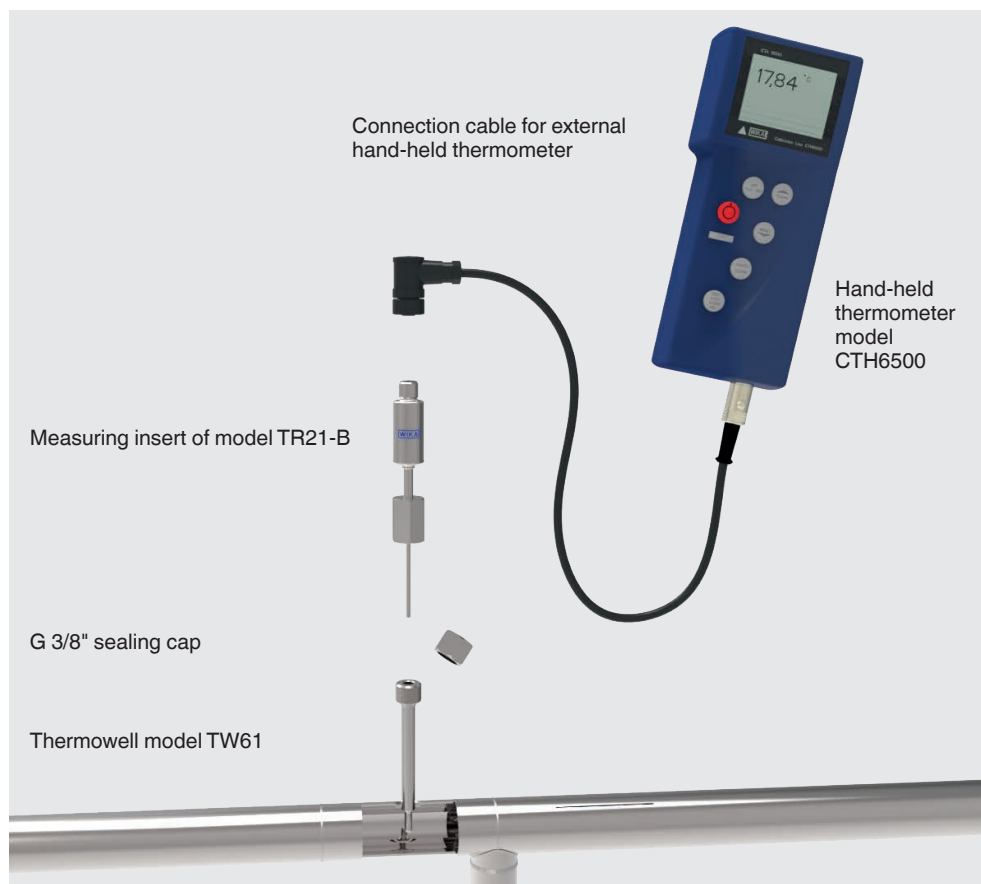

The measuring insert of the model TR21-B resistance thermometer, in combination with the model CTH6500 hand-held thermometer and the model TW61 thermowell, offers a simple and effective possibility for sterile validation of a temperature measuring point. Here, in the design phase, a model TW61 thermowell must be integrated in the pipeline, which will serve as the measuring point at a later date. To validate this measuring point, a resistance thermometer measuring insert with a spring-loaded tip is screwed into the thermowell and the temperature read from the connected hand-held thermometer.

Through a standardised sensor insertion length, temperature measurement is possible using a single thermometer, even for thermowells for different pipeline cross sections. The measuring point already available for the validation ensures that the sterile boundaries remain intact. Due to the defined contact pressure of the spring-loaded sensor and the predetermined immersion depth in the pipeline, the temperature measurement is reproducible at any time. The time needed for the measurement is low.

Further components

Components	Order number
G 3/8" sealing cap	14136849
O-ring for use with G 3/8" sealing cap	0478709
Connection cable for the connection of the resistance thermometer model TR21-B to the hand-held thermometer model CTH6500 Cable length 2 m	14131257
Hand-held thermometer model CTH6500 (data sheet CT 55.10)	14007838

Hygienic design

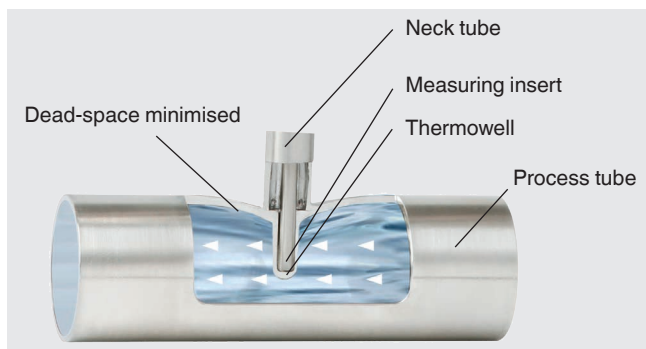











The patented hygienic design of the TW61 flow-through housing enables dead-space minimised, invasive temperature measurement and, through self-draining, a flexible mounting position.

With horizontal installation, make sure that the pipeline is slightly inclined for self-draining.

The installation is carried out by means of orbital welding. Thus, the welding seams are reproducible and controllable.

Approvals

Logo	Description	Country												
 	<p>EU declaration of conformity</p> <ul style="list-style-type: none"> EMC directive ¹⁾ EN 61326 emission (group 1, class B) and interference immunity (industrial application) Pressure equipment directive PS > 200 bar, module H, pressure accessory <p>For thermowells > DN 25 (1") and for the associated marking on the measuring instrument or thermowell, WIKA confirms conformity with the Pressure Equipment Directive in accordance with the conformity assessment procedure, module H.</p> <p>For thermowells with nominal widths of ≤ DN 25 (1"), an EC conformity evaluation in accordance with the Pressure Equipment Directive (PED) is not permitted. Those are designed and manufactured without CE marking in line with the applicable sound engineering practice (PED article 3, chapter 3).</p> <ul style="list-style-type: none"> RoHS directive ATEX directive (option) <p>Hazardous areas</p> <table border="0"> <tr> <td>Zone 0 gas</td> <td>[II 1G Ex ia IIC T1 ... T6 Ga]</td> </tr> <tr> <td>Zone 1 mounting to zone 0 gas</td> <td>[II 1/2G Ex ia IIC T1 ... T6 Ga/Gb]</td> </tr> <tr> <td>Zone 1 gas</td> <td>[II 2G Ex ia IIC T1 ... T6 Gb]</td> </tr> <tr> <td>Zone 20 dust</td> <td>[II 1D Ex ia IIIC T135 °C Da]</td> </tr> <tr> <td>Zone 21 mounting to zone 20 dust</td> <td>[II 1/2D Ex ia IIIC T135 °C Da/Db]</td> </tr> <tr> <td>Zone 21 dust</td> <td>[II 2D Ex ia IIIC T135 °C Db]</td> </tr> </table>	Zone 0 gas	[II 1G Ex ia IIC T1 ... T6 Ga]	Zone 1 mounting to zone 0 gas	[II 1/2G Ex ia IIC T1 ... T6 Ga/Gb]	Zone 1 gas	[II 2G Ex ia IIC T1 ... T6 Gb]	Zone 20 dust	[II 1D Ex ia IIIC T135 °C Da]	Zone 21 mounting to zone 20 dust	[II 1/2D Ex ia IIIC T135 °C Da/Db]	Zone 21 dust	[II 2D Ex ia IIIC T135 °C Db]	European Union
Zone 0 gas	[II 1G Ex ia IIC T1 ... T6 Ga]													
Zone 1 mounting to zone 0 gas	[II 1/2G Ex ia IIC T1 ... T6 Ga/Gb]													
Zone 1 gas	[II 2G Ex ia IIC T1 ... T6 Gb]													
Zone 20 dust	[II 1D Ex ia IIIC T135 °C Da]													
Zone 21 mounting to zone 20 dust	[II 1/2D Ex ia IIIC T135 °C Da/Db]													
Zone 21 dust	[II 2D Ex ia IIIC T135 °C Db]													
	<p>IECEx (option) - in conjunction with ATEX</p> <p>Hazardous areas</p> <table border="0"> <tr> <td>Zone 0 gas</td> <td>[Ex ia IIC T1 ... T6 Ga]</td> </tr> <tr> <td>Zone 1 mounting to zone 0 gas</td> <td>[Ex ia IIC T1 ... T6 Ga/Gb]</td> </tr> <tr> <td>Zone 1 gas</td> <td>[Ex ia IIC T1 ... T6 Gb]</td> </tr> <tr> <td>Zone 20 dust</td> <td>[Ex ia IIIC T135 °C Da]</td> </tr> <tr> <td>Zone 21 mounting to zone 20 dust</td> <td>[Ex ia IIIC T135 °C Da/Db]</td> </tr> <tr> <td>Zone 21 dust</td> <td>[Ex ia IIIC T135 °C Db]</td> </tr> </table>	Zone 0 gas	[Ex ia IIC T1 ... T6 Ga]	Zone 1 mounting to zone 0 gas	[Ex ia IIC T1 ... T6 Ga/Gb]	Zone 1 gas	[Ex ia IIC T1 ... T6 Gb]	Zone 20 dust	[Ex ia IIIC T135 °C Da]	Zone 21 mounting to zone 20 dust	[Ex ia IIIC T135 °C Da/Db]	Zone 21 dust	[Ex ia IIIC T135 °C Db]	International
Zone 0 gas	[Ex ia IIC T1 ... T6 Ga]													
Zone 1 mounting to zone 0 gas	[Ex ia IIC T1 ... T6 Ga/Gb]													
Zone 1 gas	[Ex ia IIC T1 ... T6 Gb]													
Zone 20 dust	[Ex ia IIIC T135 °C Da]													
Zone 21 mounting to zone 20 dust	[Ex ia IIIC T135 °C Da/Db]													
Zone 21 dust	[Ex ia IIIC T135 °C Db]													
	<p>CSA (option)</p> <ul style="list-style-type: none"> Safety (e.g. electr. safety, overpressure, ...) Hazardous areas <p>Class I, division 1 or 2, groups A, B, C, D T1 ... T6 Class I, zone 0 or 1, IIC Ex/AEx ia IIC T1 ... T6 Ga Class II / III, division 1 or 2, groups E, F, G T1 ... T6 / 135 °C Class II / III, zone 20 or 21, Ex / AEx ia IIIC T135 °C Da</p>	USA and Canada												
	<p>EAC (option)</p> <ul style="list-style-type: none"> EMC directive ¹⁾ Hazardous areas <table border="0"> <tr> <td>Zone 0 gas</td> <td>[0 Ex ia IIC T6...T1 Ga X]</td> </tr> <tr> <td>Zone 1 gas</td> <td>[1 Ex ia IIC T6...T1 Gb X]</td> </tr> <tr> <td>Zone 20 dust</td> <td>[Ex ia IIIC T80...T440 Da X]</td> </tr> <tr> <td>Zone 21 dust</td> <td>[Ex ia IIIC T80...T440 Db X]</td> </tr> </table>	Zone 0 gas	[0 Ex ia IIC T6...T1 Ga X]	Zone 1 gas	[1 Ex ia IIC T6...T1 Gb X]	Zone 20 dust	[Ex ia IIIC T80...T440 Da X]	Zone 21 dust	[Ex ia IIIC T80...T440 Db X]	Eurasian Economic Community				
Zone 0 gas	[0 Ex ia IIC T6...T1 Ga X]													
Zone 1 gas	[1 Ex ia IIC T6...T1 Gb X]													
Zone 20 dust	[Ex ia IIIC T80...T440 Da X]													
Zone 21 dust	[Ex ia IIIC T80...T440 Db X]													

Logo	Description	Country
	NEPSI (option) Hazardous areas Zone 0 gas [Ex ia IT C T1~T6 Ga] Zone 20 dust [Ex iaD 20 T135]	China
	UL - only for instrument version without explosion protection Safety (e.g. electr. safety, overpressure, ...)	USA and Canada
	GOST (option) Metrology, measurement technology	Russia
	KazInMetr (option) Metrology, measurement technology	Kazakhstan
-	MTSCHS (option) Permission for commissioning	Kazakhstan
	BelGIM (option) Metrology, measurement technology	Belarus
	Uzstandard (option) Metrology, measurement technology	Uzbekistan
	3-A (option) ²⁾ Sanitary Standard Flow-through housing: yes, for all dimensions Angular housing: yes, from DIN 11866 row A: DN 32 ... 100 DIN 11866 row B: DN 25 ... 80 DIN 11866 row C: DN 1 1/2" ... 4"	USA
	EHEDG (option) ²⁾ Hygienic Equipment Design Flow-through housing: yes, for all dimensions Angular housing: yes, from DIN 11866 row A: DN 32 ... 100 DIN 11866 row B: DN 25 ... 80 DIN 11866 row C: DN 1 1/2" ... 4"	European Union

1) Only for built-in transmitter

2) Confirmation of 3-A or EHEDG conformity only valid with separately selectable 2.2 test report

Instruments marked with "ia" may also be used in areas only requiring instruments marked with "ib" or "ic".

If an instrument with "ia" marking has been used in an area with requirements in accordance with "ib" or "ic", it can no longer be operated in areas with requirements in accordance with "ia" afterwards.

Certificates (option)

- 2.2 test report
- 3.1 inspection certificate
- Manufacturer's declaration regarding Regulation (EC) 1935/2004
- Certificate of the surface roughness of wetted parts
- Hygiene certificate

Patents, property rights

Dead-space free welding nipple for thermowell model TW61 (DE 102010037994 and US 12 897.080)

Approvals and certificates, see website

Ordering information

Model / Approval / Sensor or transmitter output / Sensor specification or transmitter configuration / Process temperature / Thermowell / Process connection / Material wetted parts / Insertion length U₁ / Electrical accessories / Certificates / Options

© 12/2010 WIKA Alexander Wiegand SE & Co. KG, all rights reserved.

The specifications given in this document represent the state of engineering at the time of publishing. We reserve the right to make modifications to the specifications and materials.

