

Miniature resistance thermometer Model TR33, thread-mounted

WIKA data sheet TE 60.33



for further approvals
see page 8

Applications

- Machine building, plant and vessel construction
- Propulsion technology, hydraulics

Special features

- Very compact design, high vibration resistance and fast response time
- With direct sensor output (Pt100, Pt1000 in 2-, 3- or 4-wire) or integrated transmitter with output signal 4 ... 20 mA
- Individually parameterisable for integrated transmitter with free PC configuration software WIKAsoft-TT
- Sensor element with accuracy class A per IEC 60751

Description

Resistance thermometers of this series are used as universal thermometers for the measurement of liquid and gaseous media in the range of -50 ... +250 °C (-58 ... +482 °F).

They can be used for pressures up to 140 bar with sensor diameter 3 mm and up to 270 bar with sensor diameter 6 mm, dependent on the instrument version. All electrical components are protected against humidity (IP67 or IP69K) and designed to withstand vibration (20 g, depending on the instrument version).

The resistance thermometer is available with direct sensor output or integrated transmitter, which can be configured individually via the PC configuration software WIKAsoft-TT. Measuring range, damping, fault signal per NAMUR NE43 and TAG no. can be adjusted.



Fig. left: Resistance thermometer, model TR33
Fig. right: Adapter M12 x 1 for angular connector
DIN EN 175301-803

Insertion length, process connection, sensor and connection method can each be selected for the respective application from the order information. The model TR33 resistance thermometer consists of a thermowell with fixed process connection and is screwed directly into the process. The electrical connection is made via an M12 x 1 circular connector. An adapter for electrical connection with angular connector per DIN EN 175301-803 is optionally available (patent, property right: no. 001370985).

Sensor

The sensor is located in the tip of the thermometer.

The resistance thermometers of the series TR33 are designed for direct installation into the process. Using it in an additional thermowell makes no sense.

Sensor diameter in mm	Process connection						
	G ¼ B	G ⅜ B	G ½ B	¼ NPT	½ NPT	M12 x 1.5	M20 x 1.5
3	x	x	x	x	x	x	x
6	x	x	x	x	x	x	x

Sensor tube length										
Sensor diameter in mm	Insertion length U ₁ in mm									
	50	75	100	120	150	200	250	300	350	400
3	x	-	-	-	-	-	-	-	-	-
6	x	x	x	x	x	x	x	x	x	x

Further sensor tube lengths on request.

Specifications

Thermometer with direct sensor output with Pt100 (model TR33-Z-Px) and Pt1000 (model TR33-Z-Sx)	
Temperature range ■ Class A ■ Class B	Without neck tube -30 ... +150 °C (-22 ... +302 °F) With neck tube -30 ... +250 °C (-22 ... +482 °F) Without neck tube -50 ... +150 °C (-58 ... +302 °F) With neck tube -50 ... +250 °C (-58 ... +482 °F)
Temperature at the plug	Max. 85 °C (185 °F)
Measuring element	■ Pt100 (measuring current: 0.1 ... 1.0 mA) ■ Pt1000 (measuring current: 0.1 ... 0.3 mA)
Connection method	■ 2-wire The lead resistance is recorded as an error in the measurement. ■ 3-wire With a cable length of 30 m or longer, measuring errors can occur. ■ 4-wire The lead resistance can be neglected.
Tolerance value of the measuring element per IEC 60751	■ Class A ■ Class B at 2-wire
Electrical connection	M12 x 1 circular connector (4-pin)

For detailed specifications for Pt sensors, see Technical information IN 00.17 at www.wika.com.

Thermometer with transmitter and output signal 4 ... 20 mA (model TR33-Z-TT)	
Temperature range	Without neck tube -30 ... +150 °C (-22 ... +302 °F) With neck tube -30 ... +250 °C (-22 ... +482 °F) ¹⁾
Measuring element	Pt1000
Connection method	2-wire
Tolerance value of the measuring element per IEC 60751	Class A
Measuring deviation of the transmitter per IEC 60770	±0.25 K
Total measuring deviation according to IEC 60770	Measuring deviation of the measuring element + the transmitter
Measuring span	Minimum 20 K, maximum 300 K
Basic configuration	Measuring range 0 ... 150 °C (32 ... 302 °F), other measuring ranges are adjustable
Analogue output	4 ... 20 mA, 2-wire
Linearisation	Linear to temperature per IEC 60751
Linearisation error	±0.1 % ²⁾
Switch-on delay, electrical	Max. 4 s (time before the first measured value))
Warming-up period	After approx. 4 minutes the instrument will function to the specified technical data (accuracy).
Current signal for fault signal	Configurable in accordance with NAMUR NE43 downscale ≤ 3.6 mA upscale ≥ 21.0 mA
Sensor short-circuit	Not configurable, per NAMUR NE43 downscale ≤ 3.6 mA
Sensor current	< 0.3 mA (Self-heating can be neglected)
Load R _A	$R_A \leq (U_B - 10 \text{ V}) / 23 \text{ mA}$ with R _A in Ω and U _B in V
Effect of load	±0.05 % / 100 Ω
Power supply U _B	DC 10 ... 30 V
Max. permissible residual ripple	10 % generated by U _B < 3 % ripple of the output current
Power supply input	Protected against reverse polarity
Power supply effect	±0.025 % / V (depending on the power supply U _B)
Influence of the ambient temperature	0.1 % of span / 10 K T _a
Electromagnetic compatibility (EMC) ⁴⁾	EN 61326 emission (group 1, class B) and interference immunity (industrial application) ³⁾ , configuration at 20 % of the full measuring range
Temperature units	Configurable °C, °F, K
Info data	TAG No., description and user message can be stored in transmitter
Configuration and calibration data	Permanently stored
Electrical connection	M12 x 1 circular connector (4-pin)

Case	
Material	Stainless steel
Ingress protection	
■ Case with connected plug ⁵⁾	IP67 and IP69 per IEC/EN 60529, IP69K per ISO 20653 The stated ingress protection only applies when plugged in using mating connectors that have the appropriate ingress protection.
■ Coupler connector, not connected	IP67 per IEC/EN 60529
Weight in kg	Approx. 0.2 ... 0.7 (depending on version)
Dimensions	See "Dimensions in mm"

Readings in % refer to the measuring span

1) Protect the temperature transmitter therefore from temperatures over 85 °C (185 °F).

2) ±0.2 % for measuring ranges with a lower limit less than 0 °C (32 °F)

3) Use resistance thermometers with shielded cable and ground the shield on at least one end of the lead, if the lines are longer than 30 m or leave the building. Operate the instrument grounded.

4) During transient interferences (e.g. burst, surge, ESD) take into account an increased measuring deviation of up to 2 %.

5) Not tested at UL

Ambient conditions	
Ambient temperature range	
■ Models TR33-Z-Px, TR33-Z-Sx	-50 ... +85 °C (-58 ... +185 °F)
■ Model TR33-Z-TT	-40 ... +85 °C (-40 ... +185 °F)
Storage temperature range	-40 ... +85 °C (-40 ... +185 °F)
Climate class per IEC 60654-1	
■ Models TR33-Z-Px, TR33-Z-Sx	Cx (-50 ... +85 °C or -58 ... +185 °F, 5 ... 95 % r. h.)
■ Model TR33-Z-TT	Cx (-40 ... +85 °C or -40 ... +185 °F, 5 ... 95 % r. h.)
Maximum permissible humidity per IEC 60068-2-30 var. 2	100 % r. h., condensation allowed
Maximum operating pressure ^{6) 7)}	140 bar with 3 mm sensor diameter 270 bar with 6 mm sensor diameter
Vibration resistance per IEC 60068-2-6	10 ... 2,000 Hz, 20 g ⁶⁾
Shock resistance per IEC 60068-2-27	50 g, 6 ms, 3 axis, 3 faces, 3 times for each face
Salt fog	IEC 60068-2-11

6) Depending on the instrument version

7) Reduced operating pressure when using a compression fitting: Stainless steel: max. 100 bar
PTFE: max. 8 bar

Conditions for outdoor use (for UL approval only)

- The instrument is suitable for applications with pollution degree 3.
- The power supply must be suitable for operation above 2,000 m should the temperature transmitter be used at this altitude.
- The instrument shall be installed in locations sheltered from the weather.
- The instrument shall be installed "sun/UV radiation protected".

Dimensions in mm

Process connection with tapered threads

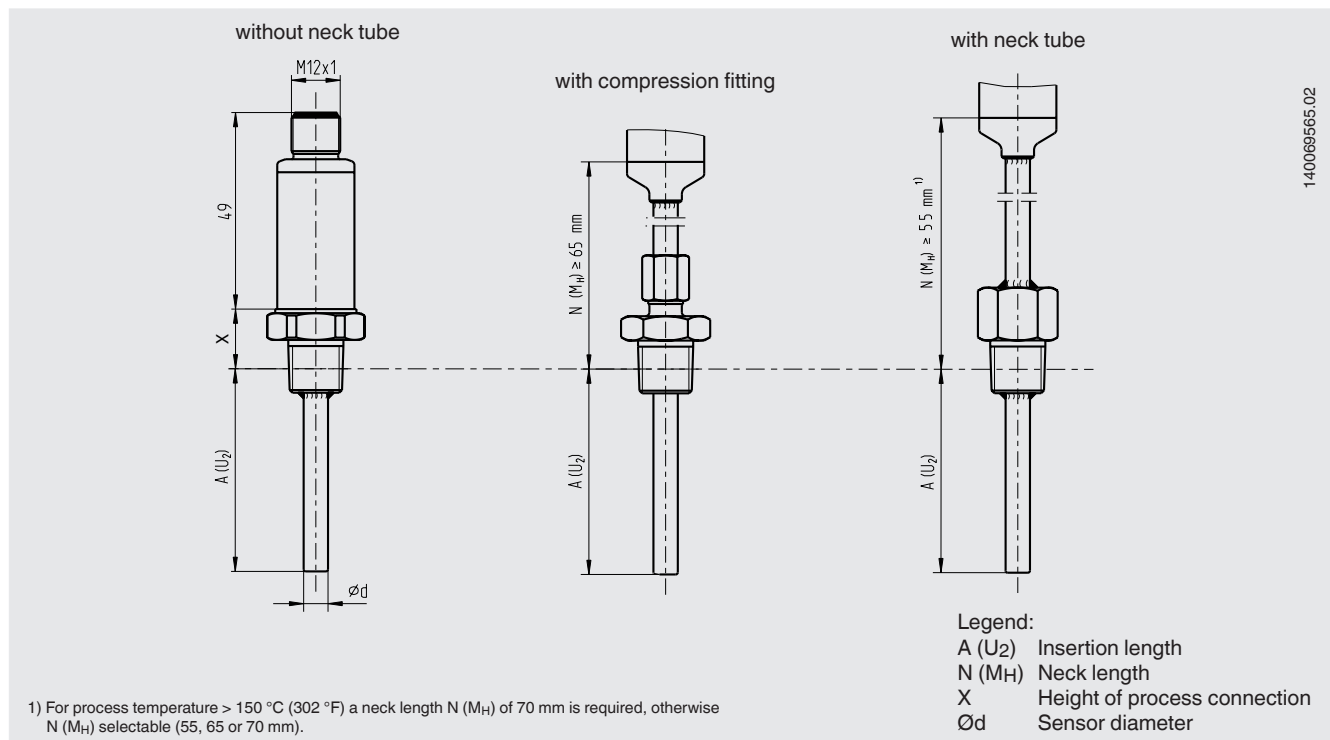

Thread	Height of process connection X
¼ NPT	15
½ NPT	19

Process connection with parallel threads (or without process connection)

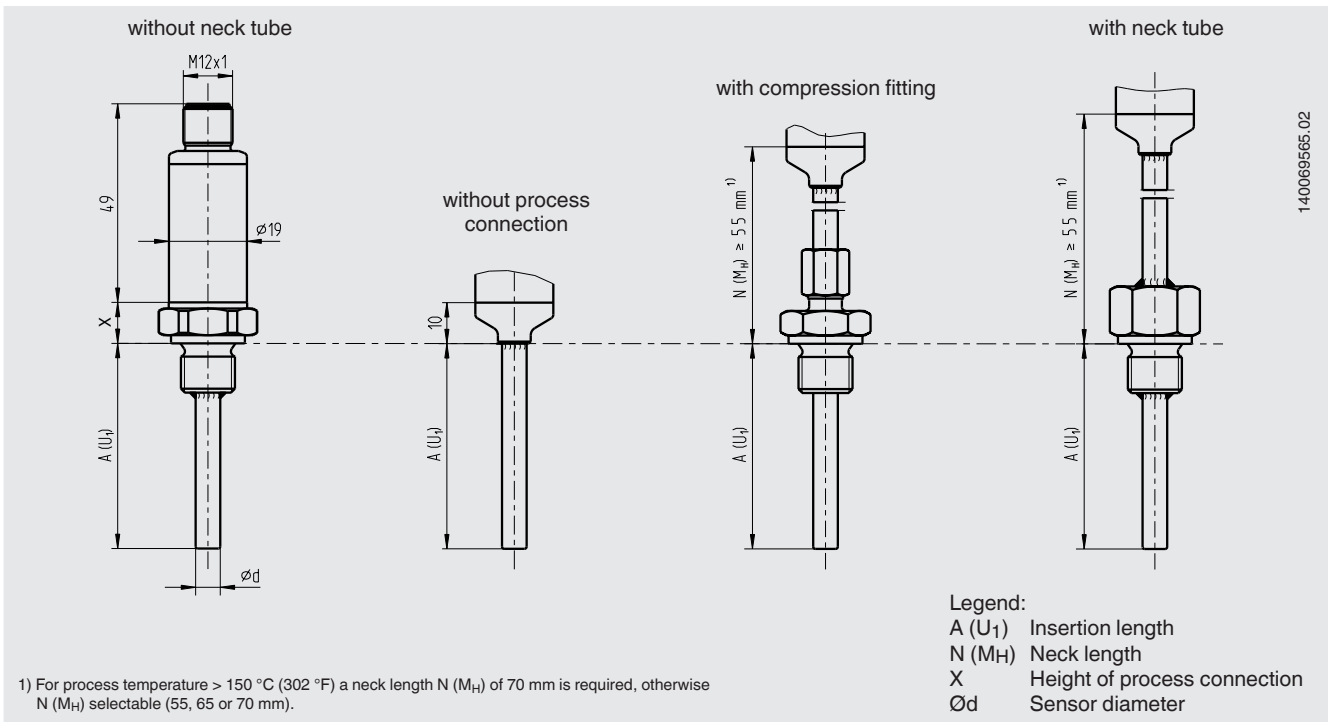





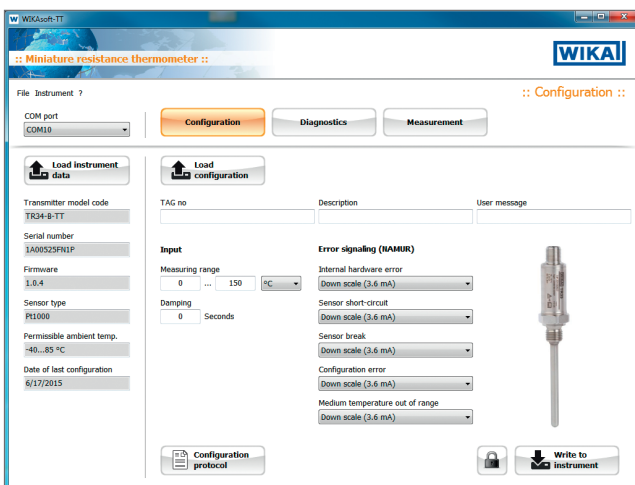

Thread	Height of process connection X
G ½	11
G ¾	11
G 1¼	10
M12	11
M20	11

Configuration software WIKAsoft-TT

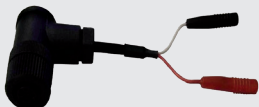
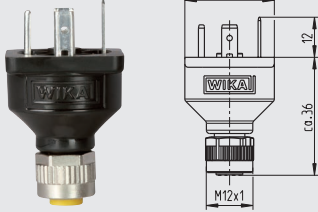
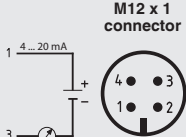

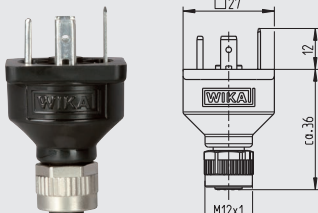
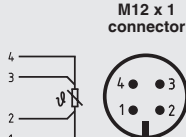
Configuration software (multilingual) as a download from www.wika.com

Accessories

Model	Special features	Order no.	
Programming unit Model PU-548 	<ul style="list-style-type: none"> ■ Easy to use ■ LED status display ■ Compact design ■ No further voltage supply needed, neither for the programming unit nor for the transmitter <p>(replaces programming unit model PU-448)</p>	14231581	
Adapter cable M12 to PU-548 	Adapter cable for the connection of a model TR33 resistance thermometer to the model PU-548 programming unit	14003193	
M12 x 1 transmitter adapter to angular connector DIN EN 175301-803 (yellow female connector element) 	Adapter for the connection of a resistance thermometer with a DIN EN 175301-803 form A angular connector with a 4 ... 20 mA output signal (data sheet AC 80.17)	14069503	
 	Case: PA Ambient temperature: -40 ... +115 °C Union nut: zinc diecast Contacts: copper-zinc alloy, tin-plated Dielectric strength: 500 V Ingress protection: IP65		
M12 x 1 Pt adapter to angular connector DIN EN 175301-803 (black female connector element) 	Adapter for the connection of the resistance thermometer with a DIN EN 175301-803 form A angular connector with direct resistance output signal (data sheet AC 80.17)	14061115	
 	Case: PA Ambient temperature: -40 ... +115 °C Union nut: zinc diecast Contacts: copper-zinc alloy, tin-plated Dielectric strength: 500 V Ingress protection: IP65		
Angular connector 	per DIN EN 175301-803 form A	11427567	
Sealing for angular connector 	for use with angular connector DIN EN 175301-803-A EPDM, brown	11437902	
M12 connection cable	Cable socket straight, 4-pin, ingress protection IP67 <ul style="list-style-type: none"> ■ Temperature range -20 ... +80 °C 	Cable length 2 m 14086880 Cable length 5 m 14086883	
	Cable socket straight, 4-pin, ingress protection IP69K <ul style="list-style-type: none"> ■ Temperature range -40 ... +80 °C 	Cable length 3 m 14137167 Cable length 5 m 14137168	
	Angled socket, 4-pin, ingress protection IP67 <ul style="list-style-type: none"> ■ Temperature range -20 ... +80 °C 	Cable length 2 m 14086889 Cable length 5 m 14086891	
	Angled socket, 4-pin, ingress protection IP69K <ul style="list-style-type: none"> ■ Temperature range -40 ... +80 °C 	Cable length 3 m 14137169 Cable length 5 m 14137170	
	M12 connector	Female angled, 4-pin, ingress protection IP67 Screw connection for conductor cross-section 0.25 ... 0.75 mm ² (24 ... 18 AWG) Cable gland Pg7, cable outer diameter 4 ... 6 mm <ul style="list-style-type: none"> ■ Temperature range -40 ... +80 °C ■ Suitable for hazardous areas 	14136815

Connecting PU-548 programming unit

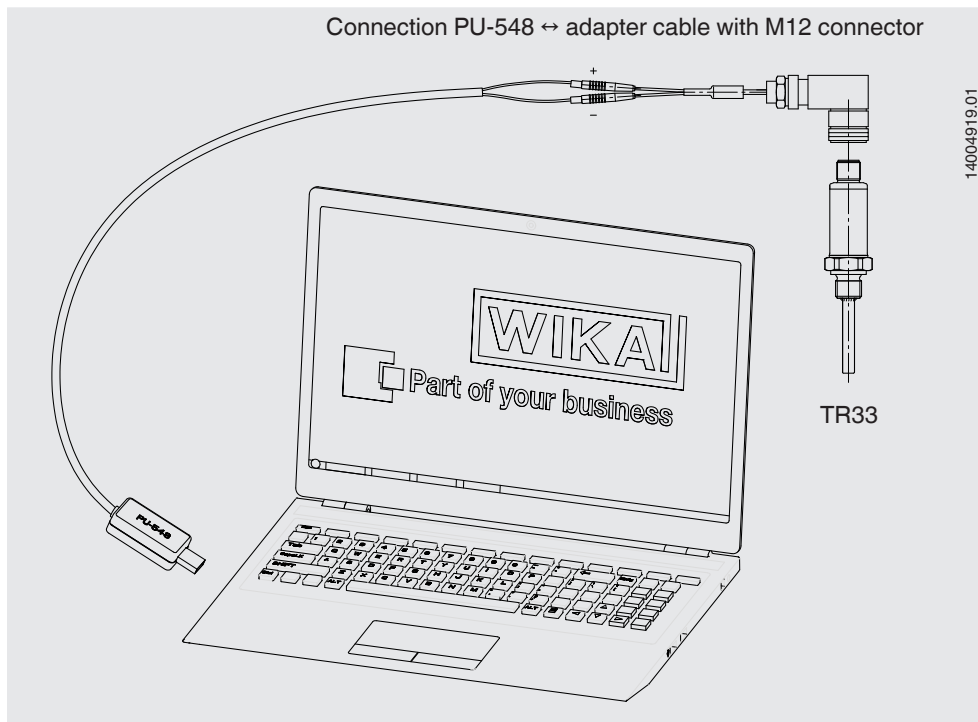

(predecessor, programming unit model PU-448, also compatible)

Electrical connection

Output signal 4 ... 20 mA

M12 x 1, 4-pin circular connector

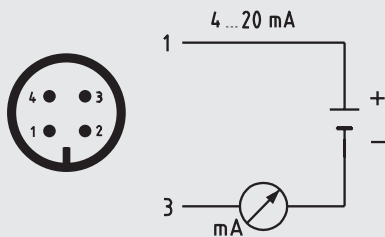

Pin	Signal	Description
1	L+	10 ... 30 V
2	VQ	not connected
3	L-	0 V
4	C	not connected

Output signal Pt100 or Pt1000 sensor

M12 x 1, 4-pin circular connector

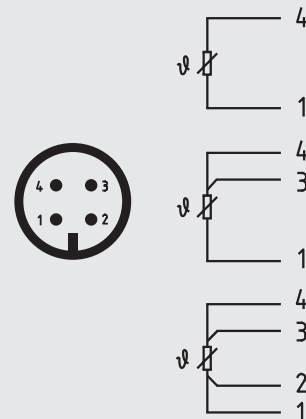





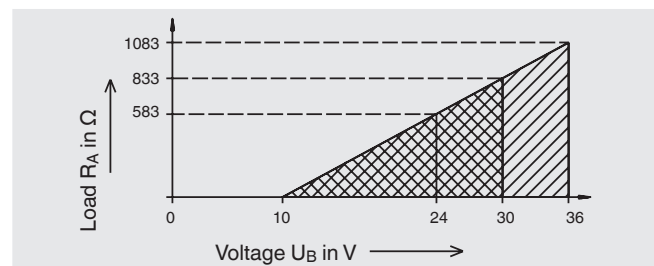



Load diagram

The permissible load depends on the loop supply voltage. For communication with the instrument with programming unit PU-548, a max. load of 350 Ω is admissible.



Approvals

Logo	Description	Country
	EU declaration of conformity <ul style="list-style-type: none"> ■ EMC directive ¹⁾ EN 61326 emission (group 1, class B) and interference immunity (industrial application) ■ RoHS directive 	European Union
	CSA (option) Safety (e.g. electr. safety, overpressure, ...)	USA and Canada
	UL (option) Safety (e.g. electr. safety, overpressure, ...)	USA and Canada
	EAC (option) Electromagnetic compatibility ¹⁾	Eurasian Economic Community
	GOST (option) Metrology, measurement technology	Russia
	KazInMetr (option) Metrology, measurement technology	Kazakhstan
-	MTSCHS (option) Permission for commissioning	Kazakhstan
	BelGIM (option) Metrology, measurement technology	Belarus
	UkrSEPRO (option) Metrology, measurement technology	Ukraine
	Uzstandard (option) Metrology, measurement technology	Uzbekistan

1) Only for built-in transmitter

Certificates (option)

Certification type	Measuring accuracy	Material certificate
2.2 test report	x	x
3.1 inspection certificate	x	x
DKD/DAkkS calibration certificate	x	-

The different certifications can be combined with each other.

Approvals and certificates, see website

Patents, property rights

M12 x 1 adapter to DIN EN 175301-803 angular connector (001370985)

Ordering information

Model / Output signal / Transmitter temperature unit / Process temperature / Transmitter initial value / Transmitter end value / Process connection / Sensor diameter / Insertion length A (U₁) or A (U₂) / Neck length N (M_H) / Accessories / Certificates

© 04/2013 WIKA Alexander Wiegand SE & Co. KG, all rights reserved.
 The specifications given in this document represent the state of engineering at the time of publishing.
 We reserve the right to make modifications to the specifications and materials.

