

Measuring insert For thermocouple Model TC10-A

WIKA data sheet TE 65.01



for further approvals
see page 2

Applications

- Replacement measuring insert for servicing
- For all industrial and laboratory applications

Special features

- Sensor ranges from $-40 \dots +1,200 \text{ }^{\circ}\text{C}$ ($-40 \dots +2,192 \text{ }^{\circ}\text{F}$)
- Made of mineral-insulated sheathed measuring cable
- Functional safety (SIL) with model T32 temperature transmitter
- Spring-loaded design
- Explosion-protected versions



Measuring insert, model TC10-A

Description

The measuring inserts per DIN 43735 for resistance thermometers described here are designed for installation in a protective fitting. Operation without thermowell is only recommended in certain applications. The measuring insert is made of a bendable mineral-insulated sheathed cable. The thermocouple is located at the tip of the measuring insert. The measuring inserts are delivered with pressure springs to ensure that the measuring inserts are pressed down to the thermowell bottom.

Apart from the DIN versions, customer-specific versions are available, for example:

- other measuring insert lengths (also intermediate lengths)
- with mounted sleeve to suit inner diameter of the thermowell
- without terminal block
- with transmitter

Type and number of sensors, and accuracy can each be selected to suit the respective application.

The range of applications is completed by designs without terminal block for direct transmitter installation. Optionally, transmitters from the WIKA range can be installed.

Explosion protection (option)











The permissible power P_{max} as well as the permissible ambient temperature for the respective category can be seen on the EC-type examination certificate, the Ex certificate or in the operating instructions.

Attention:

Depending on the version, the measuring inserts can be used in “intrinsically safe Ex i” or “non-incendive Ex n” ignition protection types when built into model TC10-B, TC10-C, TC10-F or TC81 thermocouples. With the correspondingly suitable protective fitting, operation in dust Ex hazardous areas is possible.

The use of a model TC10-A measuring insert is not permitted in hazardous areas without a suitable protective fitting.

Approvals (explosion protection, further approvals)

Logo	Description	Country
	EU declaration of conformity <ul style="list-style-type: none"> ■ EMC directive ¹⁾ EN 61326 emission (group 1, class B) and interference immunity (industrial application) ■ RoHS directive ■ ATEX directive (option) Hazardous areas <ul style="list-style-type: none"> - Ex i Zone 1 gas [II 2G Ex ia IIC T1 ... T6 Gb] - Ex n Zone 2 gas [II 3G Ex nA IIC T1 ... T6 Gc X] 	European Union
		
	IECEx (option) (in conjunction with ATEX) Hazardous areas - Ex i Zone 1 gas [Ex ia IIC T1 ... T6 Gb]	International
	EAC (option) Hazardous areas - Ex i Zone 1 gas [1 Ex ib IIC T3/T4/T5/T6] - Ex n Zone 2 gas [Ex nA IIC T6 ... T1]	Eurasian Economic Community
	INMETRO (option) Hazardous areas - Ex i Zone 1 gas [Ex ib IIC T3 ... T6 Gb]	Brazil
	NEPSI (option) Hazardous areas - Ex i Zone 1 gas [Ex ib IIC T3 ~ T6] - Ex n Zone 2 gas [Ex nA IIC T1 ~ T6 Gc]	China
	KCs - KOSHA (option) Hazardous areas - Ex i Zone 1 gas [Ex ib IIC T4 ... T6]	South Korea
-	PESO (option) Hazardous areas - Ex i Zone 1 gas [Ex ib IIC T3 ... T6 Gb]	India
	GOST (option) Metrology, measurement technology	Russia
	KazInMetr (option) Metrology, measurement technology	Kazakhstan
-	MTSCHS (option) Permission for commissioning	Kazakhstan
	BelGIM (option) Metrology, measurement technology	Belarus

1) Only for built-in transmitter

Logo	Description	Country
	UkrSEPRO (option) Metrology, measurement technology	Ukraine
	Uzstandard (option) Metrology, measurement technology	Uzbekistan

Manufacturer's information and certifications

Logo	Description
	NAMUR NE24 Hazardous areas (Ex i)

Instruments marked with "ia" may also be used in areas only requiring instruments marked with "ib" or "ic".
If an instrument with "ia" marking has been used in an area with requirements in accordance with "ib" or "ic", it can no longer be operated in areas with requirements in accordance with "ia" afterwards.

Approvals and certificates, see website

Sensor

Thermocouple per IEC 60584-1 or ASTM E230

Types K, J, E, N, T (single or dual thermocouple)

Measuring point

- Ungrounded (standard)
- Grounded

Sensor types

Type	Operating temperatures of the thermocouple			
	IEC 60584-1		ASTM E230	
	Class 2	Class 1	Standard	Special
K	-40 ... +1,200 °C	-40 ... +1,000 °C	0 ... 1,260 °C	
J	-40 ... +750 °C	-40 ... +750 °C	0 ... 760 °C	
E	-40 ... +900 °C	-40 ... +800 °C	0 ... 870 °C	
N	-40 ... +1,200 °C	-40 ... +1,000 °C	0 ... 1,260 °C	
T	-40 ... +350 °C		0 ... 370 °C	

The table shows the temperature ranges listed in the respective standards, in which the tolerance values (class accuracies) are valid.

The actual operating temperature of the thermometers is limited both by the maximum permissible working temperature and the diameter of the thermocouple and the MI cable, as well as by the maximum permissible working temperature of the thermowell material.

For detailed specifications for thermocouples, see IEC 60584-1 or ASTM E230 and Technical information IN 00.23 at www.wika.com.

Tolerance value

For the tolerance value of thermocouples, a cold junction temperature of 0 °C has been taken as the basis.

Electrical connection

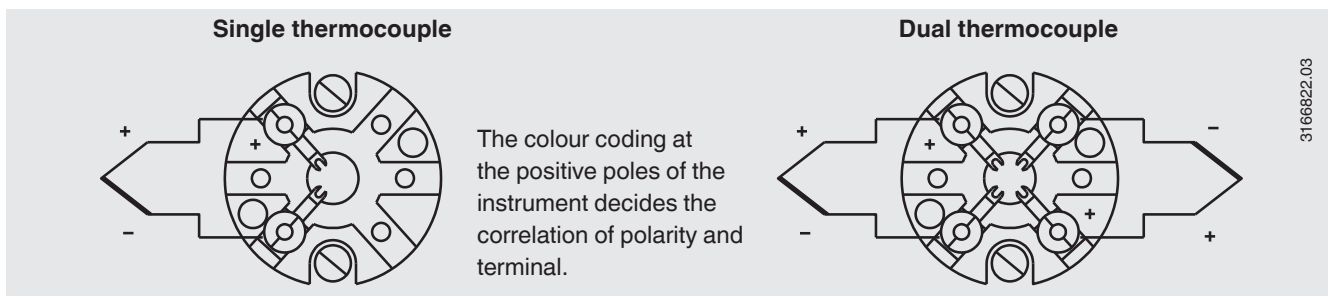

3166822.03

For the electrical connections of built-in temperature transmitters see the corresponding data sheets or operating instructions.

Transmitter (option)

A transmitter can be built upon the measuring insert. In this case, the transmitter replaces the terminal block and is directly attached to the terminal plate of the measuring insert. The temperature transmitter should be protected from temperatures over 85 °C.



Output signal 4 ... 20 mA, HART® protocol, FOUNDATION™ Fieldbus and PROFIBUS® PA			
Transmitter (selectable versions)	Model T16	Model T32	Model T53
Data sheet	TE 16.01	TE 32.04	TE 53.01
Output			
■ 4 ... 20 mA	x	x	
■ HART® protocol		x	
■ FOUNDATION™ Fieldbus and PROFIBUS® PA			x
Input			
■ Thermocouple IEC 60584-1	K, J, E, N, T	K, J, E, N, T	K, J, E, N, T
Galvanic isolation	yes	yes	yes

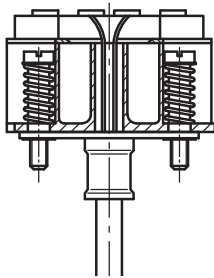

Measuring insert with mounted transmitter
(here: Model T32)

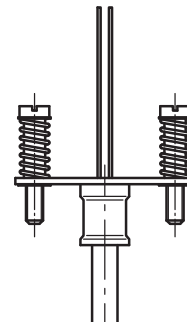

Measuring insert prepared for transmitter mounting

Functional safety (option) with temperature transmitter model T32



In safety-critical applications, the entire measuring chain must be taken into consideration in terms of the safety parameters. The SIL classification allows the assessment of the risk reduction reached by the safety installations.

Selected TC10-A measuring inserts in combination with a suitable temperature transmitter (e.g. model T32.1S, TÜV certified SIL version for protection systems developed in accordance with IEC 61508) are suitable as sensors for safety functions to SIL 2.

Matched thermowells allow easy dismounting of the measuring insert for calibration. The optimally matched measuring point consists of a thermowell, a thermometer with built-in TC10-A measuring insert and a T32.1S transmitter developed in accordance with IEC 61508. Thus, the measuring point provides maximum reliability and a long service life.

Dimensions in mm

The replaceable measuring insert is made of a vibration-resistant, sheathed measuring cable (MI cable).

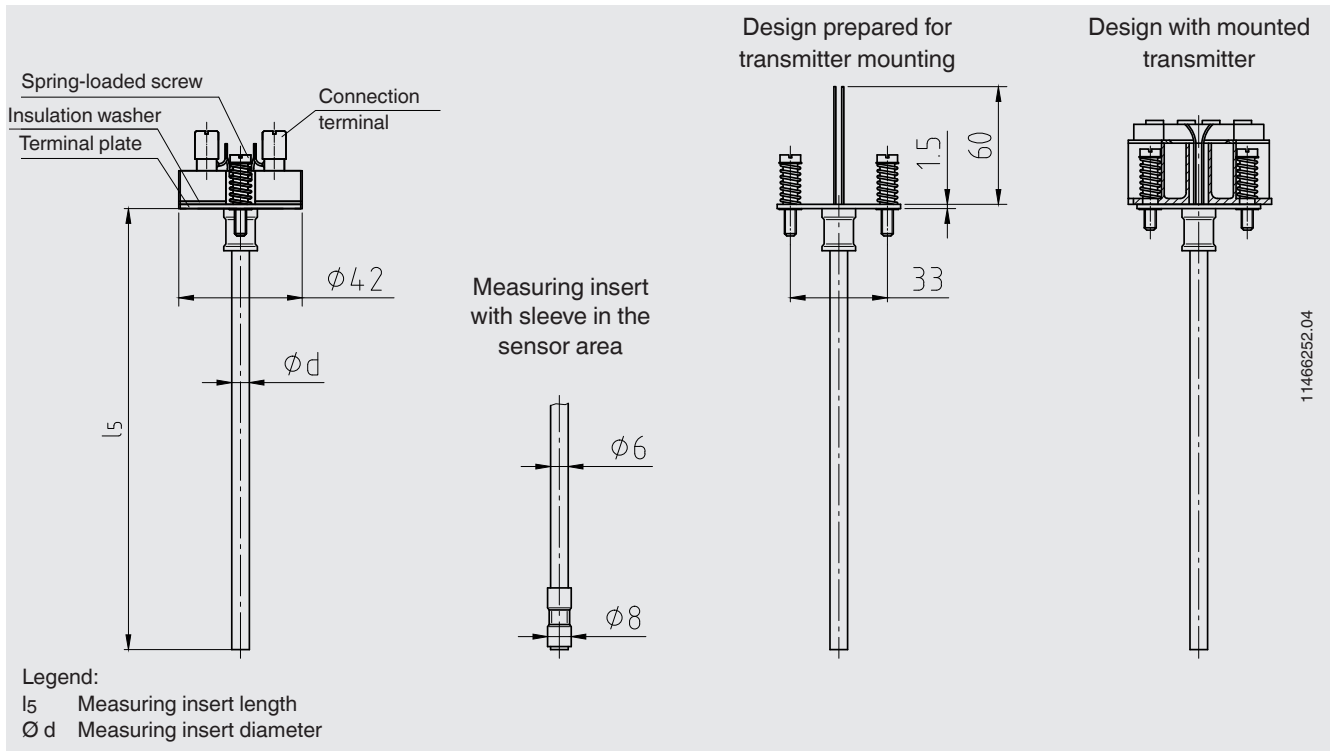

Measuring insert length l_5 in mm	Tolerance in mm
75 ... 825	+2 0
> 825	+3 0

Please note:

Measuring inserts from a length of 1,100 mm are delivered wound in a ring shape.

Only on explicit request do we deliver measuring inserts with lengths of greater than 1,100 mm in a stretched, straight form. To specify this in the order, please contact your WIKA contact person.

Measuring insert diameter $\varnothing d$ in mm		Index per DIN 43735	Tolerance in mm
3 ¹⁾	Standard	30	3 ± 0.05
6	Standard	60	$6 \begin{smallmatrix} 0 \\ -0.1 \end{smallmatrix}$
8 (6 mm with sleeve)	Standard	-	$8 \begin{smallmatrix} 0 \\ -0.1 \end{smallmatrix}$
8	Standard	80	$8 \begin{smallmatrix} 0 \\ -0.1 \end{smallmatrix}$
1/8 inch (3.17 mm) 1/4 inch (6.35 mm) 3/8 inch (9.53 mm)	Option, on request	-	-

Only correct measuring insert length and correct measuring insert diameter ensure sufficient heat transfer from thermowell to the measuring insert.

The bore diameter of the thermowell should be a max. 1 mm larger than the measuring insert diameter.

Gaps of more than 0.5 mm between thermowell and the measuring insert will have a negative effect on the heat

transfer, and they will result in unfavourable response behaviour of the thermometer.

When fitting the measuring insert into a thermowell, it is very important to determine the correct insertion length (= thermowell length for bottom thicknesses of ≤ 5.5 mm). In order to ensure that the measuring insert is firmly pressed down onto the bottom of the thermowell, the measuring insert must be spring-loaded (spring travel: max. 10 mm).

Materials

Material	
Sheath material	Ni alloy: alloy 600

Other sheath materials on request.

Certificates (option)

Certification type	Measurement accuracy	Material certificate
2.2 test report	x	x
3.1 inspection certificate	x	x
DKD/DAkkS calibration certificate	x	-

The different certifications can be combined with each other.

Operating conditions

The replaceable measuring insert is made of a vibration-resistant, sheathed measuring cable (MI cable).
Standard vibration resistance: 50 g (sensor tip)

Ambient and storage temperature

-60 ¹⁾ / -40 ... +80 °C

1) Special version on request (explosion-protected versions only available with specific approvals)

Other ambient and storage temperatures on request

Ingress protection

IP00 per IEC/EN 60529

The measuring inserts for the model TC10-A are designed for mounting into protective components (connection head + protection tube/thermowell).

These protective components feature connection heads/cable glands/thermowells/protection tubes which ensure a higher IP protection.

Ordering information

Model / Explosion protection / Ignition protection type / Zone / Sensor / Class accuracy / Application range of the thermometer / Measuring insert length l_5 / Measuring insert diameter $\varnothing d$ / Sheath material / Mechanical requirements / Certificates / Options

© 09/2003 WIKA Alexander Wiegand SE & Co. KG, all rights reserved.
The specifications given in this document represent the state of engineering at the time of publishing.
We reserve the right to make modifications to the specifications and materials.

