

Bourdon tube pressure gauge Test gauge series, class 0.1 Model 342.11

WIKA data sheet PM 03.03



for further approvals
see page 2

Applications

- For gaseous and liquid media that are not highly viscous or crystallising
- Precision measurement in laboratories
- High-accuracy pressure measurement
- Testing of industrial type pressure gauges

Special features

- Knife edge pointer and dial with mirror band scale for optimal accuracy of reading
- Precise movement with wear parts of argentan
- Particularly easy-to-read scale due to nominal size 250
- Scale ranges up to 0 ... 1,600 bar



Test gauge series model 342.11

Description

Design

EN 837-1, including transport case and acceptance test certificate (individual listing of the calibration points)

Nominal size in mm

250

Accuracy class

0.1

Scale ranges

0 ... 1 to 0 ... 1,600 bar

or all other equivalent vacuum or combined pressure and vacuum ranges

Adjustment medium

≤ 25 bar: Gas

> 25 bar: Water

Pressure limitation

Steady: Full scale value

Fluctuating: 0.9 x full scale value

Permissible temperature

Ambient: -20 ... +60 °C

Medium: +100 °C maximum

Temperature effect

When the temperature of the measuring system deviates from the reference temperature (+20 °C): max. ±0.1 %/10 K of full scale value

Ingress protection

IP54 per IEC/EN 60529

Standard version

Process connection

Stainless steel

Lower mount (radial) or lower back mount

G ½ B (male), SW 22

Pressure element

Ni-Fe alloy

< 100 bar: C-type

≥ 100 bar: Helical type

Movement

Copper alloy, wear parts argentan

Dial

Aluminium, white, black lettering, scale 330°, with mirror band scale, for zero adjustment rotatable by ±15°

Pointer

Knife edge pointer, aluminium, black

Case

Flange ring type case, aluminium, black-silver

Window

Clear non-splintering plastic, green tinted to prevent the dazzle effect







Bezel ring

Flange ring, aluminium, black-silver

Options

- Other process connection
- Adjustment medium water with scale ranges ≥ 4 bar
- Surface mounting flange
- Suitable for panel mounting (by means of clamp)
- After-sales service booklet for 3 recalibrations
- Capsule pressure gauge for low pressures from 0 ... 6 mbar (model 612.11, see data sheet PM 06.04)

Approvals

Logo	Description	Country
	EU declaration of conformity Pressure equipment directive, PS > 200 bar; module A, pressure accessory	European Union
	EAC (option) Pressure equipment directive	Eurasian Economic Community
	GOST (option) Metrology, measurement technology	Russia
	KazInMetr (option) Metrology, measurement technology	Kazakhstan
-	MTSCHS (option) Permission for commissioning	Kazakhstan
	BelGIM (option) Metrology, measurement technology	Belarus
	UkrSEPRO Metrology, measurement technology	Ukraine
	Uzstandard (option) Metrology, measurement technology	Uzbekistan
-	CPA (option) Metrology, measurement technology	China
-	CRN Safety (e.g. electr. safety, overpressure, ...)	Canada

Certificates (option)

- 2.2 test report per EN 10204 (e.g. state-of-the-art manufacturing, material proof, indication accuracy)
- 3.1 inspection certificate per EN 10204 (e.g. material proof for wetted metallic parts, indication accuracy)
- DKD/DAkkS certified accuracy

Approvals and certificates, see website

Dimensions in mm

Standard version

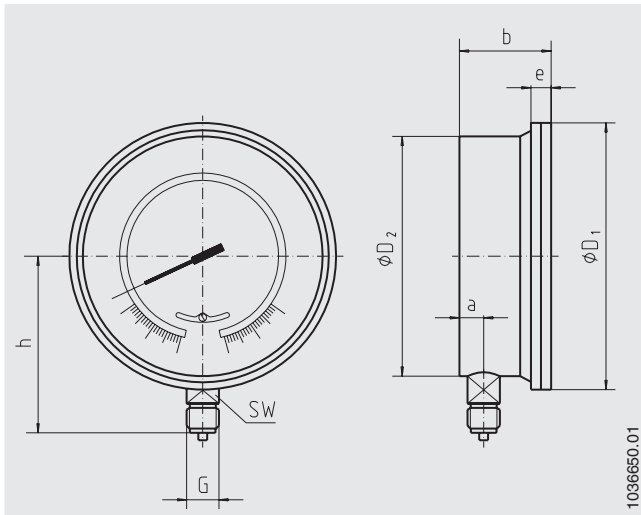

NS	Dimensions in mm								Weight in kg
	a	b	D ₁	D ₂	e	G	h ±1	SW	
250	22	78	277	250	16.5	G ½ B	165	22	6.0

Process connection per EN 837-1 / 7.3

Ordering information

Model / Nominal size / Scale range / Process connection / Connection location / Adjustment medium / Options

© 03/2008 WIKA Alexander Wiegand SE & Co. KG, all rights reserved.
The specifications given in this document represent the state of engineering at the time of publishing.
We reserve the right to make modifications to the specifications and materials.

