

**WE PROVIDE PRODUCTS
WHICH ENSURE
SAFETY AND QUALITY, DO YOU ?**

**SPECIALIST
FOR BOILER EQUIPMENT
SINCE 2005**



MEDAN OFFICE

Jl. Brigjen Zein Hamid,
Komp. Katamso Vista Blok. B7-10
Medan - Titi Kuning 20146 - Indonesia
Telp. : (061) - 786 2299
Fax. : (061) - 787 4188

JAKARTA OFFICE

Jl. Daan Mogot, KM.18
Green Sedayu Bizpark Unit DM 5 No.2
Jakarta Barat 11840 Indonesia
Telp. : (021) - 2252 2441
Fax. : (021) - 2252 2442

PRESSURE MEASUREMENT



**PRESSURE GAUGE
PROCESS
MODEL : 233.50**



**PRESSURE GAUGE
BOILER
MODEL : 211.11**



**PREMIUM PRESSURE
TRANSMITTER
MODEL : S-20**



**ACCESSORIES
SYPHONE
MODEL : 910.15**



**DRAFT GAUGE
MODEL: 614.11**



TEMPERATURE MEASUREMENT



**BIMETAL
TEMPERATURE
GAUGE
MODEL : S55**



**THERMOWELL
FOR TEMPERATURE
ELEMENT
MODEL : TW-10**



**GAS
ACTUATED
THERMOMETER
MODEL : F-73**



**ELECTRONIC
TEMPERATURE
ELEMENT
MODEL : RTD/TC**



**PID
TEMPERATURE
CONTROLLER
MODEL : CS6S**



CALIBRATOR MEASUREMENT

LEVEL SWITCH MEASUREMENT



**PRECISION
DIGITAL
PRESSURE GAUGE
MODEL : CPG1500**



**DRY WELL
CALIBRATOR
MODEL : CTD9100**



**BY PASS LEVEL
INDICATOR WITH
MAGNETIC DISPLAY
MODEL : BNA**



**HIGH PRESSURE
FLOAT
SWITCH
MODEL : ELS**



**DIFFERENTIAL
PRESSURE
TRANSMITTER
MODEL : DPT-10**



FLOW & LEVEL MEASUREMENT



**FLOWMETER
ELEMENT - ORIFICE
PLATE
MODEL : FLC-OP**



**PRESSURE
REDUCING
VALVE
MODEL : FLC-OM**



**REFLEX
LEVEL GAUGE
MODEL : LGG-RP**



**TRANSPARENT
SIGHT GLASS
LEVEL GAUGE
MODEL : LGG-TP**



**LEVEL GLASS
WITH
TEMPERATURE
MODEL : LGG-TP-IL**



ADCA PRODUCT



**THERMODYNAMIC
STEAM TRAP
MODEL : DT-46**



**BALL FLOAT
& THERMOSTATIC
STEAM TRAP
MODEL : FLT-32**



**INTERMITTENT
BLOWDOWN
VALVE
MODEL : VPA-26S**



**PRESSURE
REDUCING VALVE
MODEL : RP-45S**



**PNEUMATIC
CONTROL
VALVE
MODEL : PV-25S**



VTV GLOBE VALVE



**DIN STANDARD
GLOBE VALVE
MODEL : GBV-201**



**ANGEL
GLOBE VALVE
MODEL : GBV-203**



**ANSI STANDARD
GLOBE VALVE
MODEL : GBV-201**



**Y TYPE
GLOBE VALVE
MODEL : GBV-Y**



**FORGED STEEL
GLOBE VALVE
MODEL : GBV-301**



VTV PRODUCT



**RISING STEM
DIN STANDARD
GATE VALVE
MODEL : GV-202**



**RISING STEM
ANSI STANDARD
GATE VALVE
MODEL : GV-202**



**RISING STEM
FORGED STEEL
GATE VALVE
MODEL : GV-301**



**LIFT
CHECK VALVE
MODEL : LC-208**



**SWING
CHECK VALVE
MODEL : SC-209**



VTV PRODUCT



**DISCO
CHECK VALVE
MODEL : DC-207**



**TILTING
SWING
CHECK VALVE**



**DUMPER
VALVE
MODEL : BV-800**



**Y-STRAINER
MODEL : STV-203**



**SAFETY
VALVE
MODEL : 6301**



BOILER PRODUCT

**SUPERFLOW
DIFFERENTIAL PRESSURE
TRANSMITTER
MODEL : BM55**



**ELECTROMAGNETIC
FLOWMETER
SENSOR
MODEL : KF SERIES**



**DAMPER
CYLINDER
MODEL : FST**



**ELECTRO
PNEUMATIC
POSITIONER
MODEL : YT-1000/R**



**FEEDWATER
CONTROL VALVE
MODEL : SB SERIES**



**SPIRAL WOUND
GASKET**



**AXE
CONTROLLER**



**YOKOGAWA
DIFFERENTIAL PRESSURE
TRANSMITTER**



**SUPERFLOW
DIGITAL PRESSURE
TRANSMITTER**



**MOBREY
TOP MOUNTING
LEVEL SWITCH**



APPLICATION

SMOKE DENSITY METER

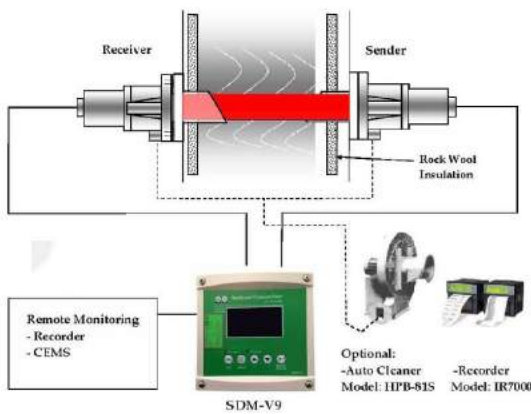

BOILER AUTOMATIC BLOWDOWN VALVE

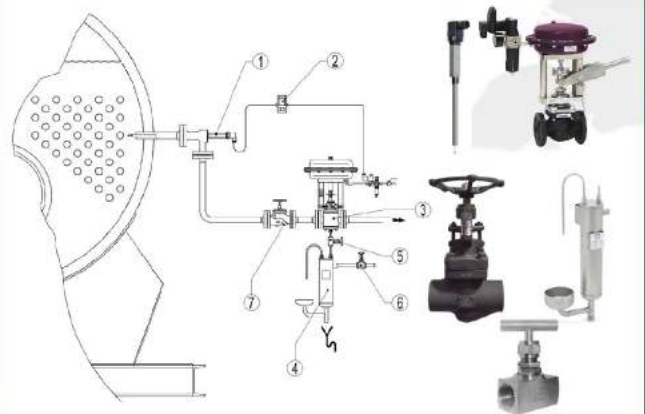

WATER LEVEL CONTROL SYSTEM

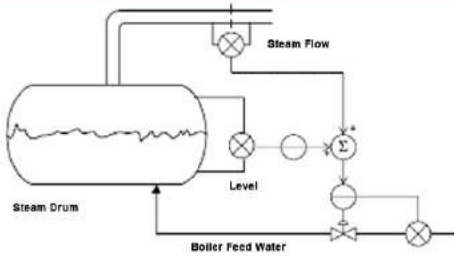

BACK PRESSURE RECEIVER SYSTEM

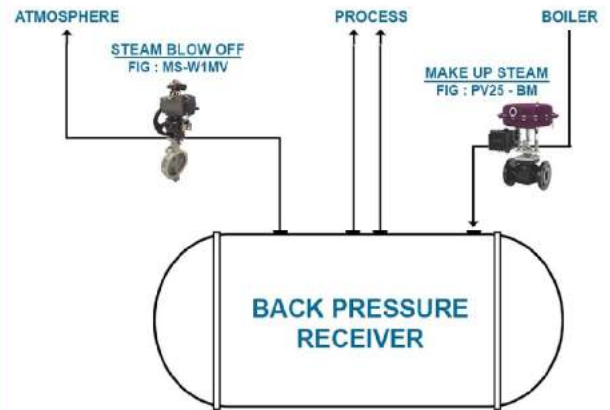

STERILIZER AUTOMATIC CONTROL SYSTEM

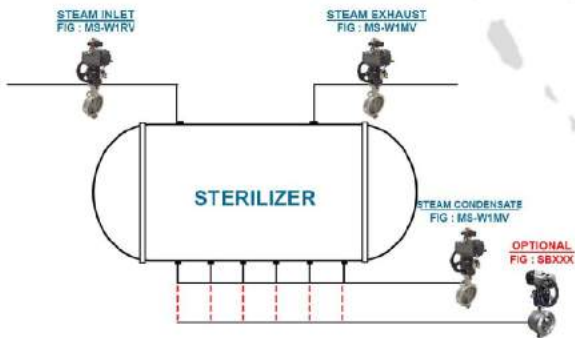

DIGESTER AUTOMATIC CONTROL SYSTEM



SAND TRAP TANK AUTOMATIC CONTROL SYSTEM

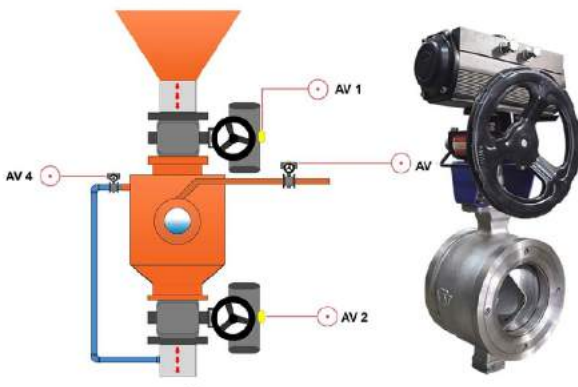

DRAFT GAUGE INDICATOR & RECORDER



DAERATOR AUTOMATIC CONTROL SYSTEM

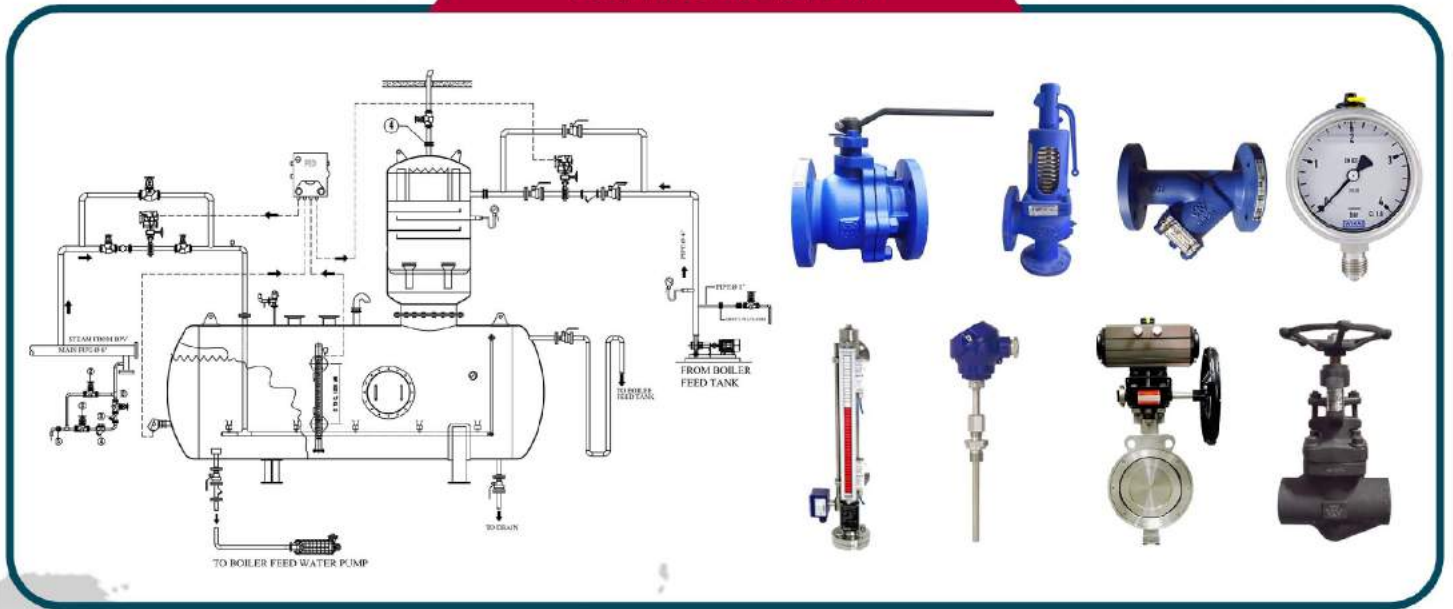

COMPANY PROFILE



Established in 2004, PT. Budijaya Makmursentosa strives to be a leading engineering supplier to offer the most complete selection of instruments and mechanicals for Palm Oil Mills, Refineries, Oil & Gas, Pulp & Papers, Mining Pharmaceutic, Petrochemical, Bio-Diesel and General Industries. The company is committed to provide solution and exceed the expectation of our customers

through high-quality products, competitive - price, warranty, and service after sales. Since its establishment, PT. Budijaya Makmursentosa has proven outstanding reputation and gained trust from its principals and customers in establishing excellent business relationship. Supported with professional sales team and qualified project engineers, PT. Budijaya Makmursentosa is dedicated to accomplish all requirements to achieve highest level of customer satisfaction.



AUTHORIZED AGENT / DISTRIBUTOR / STOCKIST :



SUPERFLOW

